



PSIBVU78
PULSE ELECTRONICS

[Buy Now](#)



Looking for a discount?

[Check out our current promotions!](#)

Give us a call

1-855-837-4225

International: 1-415-281-3866

Email Us

Sales and New Orders: sales@verical.com

Order Support: support@verical.com

Suppliers: [Visit our seller page](#)

Company Address

Arrow Electronics, Inc
9201 East Dry Creek Road
Centennial, CO 80112

Description: In Building Public Safety
Antenna 132-174 / 380-570 / 700-960 MHz

Series: V-Thinity V/H/7/8

PART NUMBER: PSIBVU78 / PSIBVU78IP

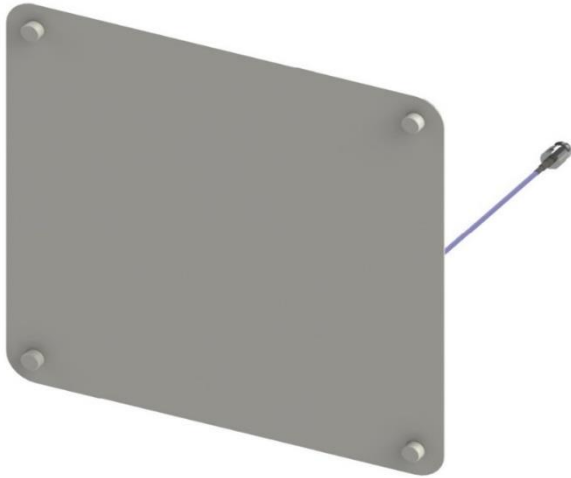

Installed Antenna

Features:

- Wide Bandwidth VHF, UHF, 7/800
 - 132-174 MHz
 - 380-570 MHz
 - 700-960 MHz
- Aesthetically pleasing:
 - 1.5mm (0.060 inch) thickness to ceiling.
- VSWR < 2:1
- Optimized to low frequency in-building environments.
- Weatherproof IP65 model available

Applications:

- In Building Repeater Systems
 - Bi-Directional Amplifiers
- Police, Fire, Government critical communication enhancement
- Low-profile ceiling mounting
- Enhanced for In-building:
 - Modest Gain
 - Multi-Floor coverage
 - Avoid nulls of traditional dipoles.

All dimensions are in mm / inches

Issue: 1907

In the effort to improve our products, we reserve the right to make changes judged to be necessary.

CONFIDENTIAL AND PROPRIETARY INFORMATION

This document contains confidential and proprietary information of Pulse Electronics, Inc. (Pulse) and is protected by copyright, trade secret and other state and federal laws. Its receipt or possession does not convey any rights to reproduce, disclose its contents, or to manufacture, use or sell anything it may describe. Reproduction, disclosure or use without specific written authorization of Pulse is strictly forbidden.

For more information:

Pulse Worldwide Headquarters
12220 World Trade Drive
San Diego, CA 92128
USA
Tel: 1-858-674-8100

Pulse/Larsen Antennas
18110 SE 34th St Bldg 2 Suite 250
Vancouver, WA 98683
USA
Tel: 1-360-944-7551

Europe Headquarters
Pulse GmbH & Do, KG
Zeppelinstrasse 15
Herrenberg, Germany
Tel: 49 7032 7806 0

Pulse (Suzhou) Wireless Products Co, Inc.
99 Huo Ju Road(#29 Bldg,4th Phase
Suzhou New District
Jiangsu Province, Suzhou 215009 PR China
Tel: 86 512 6807 9998



Description: In Building Public Safety
Antenna 132-174 / 380-570 / 700-960 MHz

Series: V-Thinity V/H/7/8

PART NUMBER: PSIBVU78 / PSIBVU78IP

This document covers all product variants of the following product family

Product	Ingress Protection
PSIBVU78	N.A
PSIBVU78IP	IP65

Note:

PSIBVU78IP is same as PSIBVU78 except applying additional epoxy to seal the antenna (PSIBVU78IP) cover to meet the IP65 rated ingress protection requirement.

Both of these 2 antennas have the same antenna performance and form factor.



Description: In Building Public Safety
Antenna 132-174 / 380-570 / 700-960 MHz

Series: V-Thinity V/H/7/8

PART NUMBER: PSIBVU78 / PSIBVU78IP

ELECTRICAL SPECIFICATIONS.

Frequency	132-174 / 380-570 / 700-960 MHz
Nominal Impedance	50 Ω
VSWR	2:1*
Power Withstand	25 watts
Connector Type	N Female
Cable Type	Ø 4mm / 0.16"
Cable length	500mm / 19.7"

*antenna mounted against ceiling tile with 2ft x 2ft metal suspension frame

This antenna cannot be mounted directly on metal surface. Contact *PulseLarsen* at antennas.us@pulseelectronics.com for any needed technical installation supportc

Description: In Building Public Safety
Antenna 132-174 / 380-570 / 700-960 MHz

Series: V-Thinity V/H/7/8

PART NUMBER: PSIBVU78 / PSIBVU78IP

MECHANICAL SPECIFICATIONS.

Color	White
Weight:	675 grams
Cable retention: Pull off	30 N
Fixing system	4pcs M6 hex slot bolt & nut

ENVIRONMENTAL SPECIFICATIONS

Operating temperature	-40 - 85° C
Storage temperature	MIL STD 801G: 24h at 85C and 24h at -40C
Temperature shock	MIL STD 810G: Method 503.5, -40 for 1 hr to +85 C for 1 hr @ 15 deg.C/min rate of change; 3 cycles
Humidity	MIL STD 810G: 24h at 60C and 95%RH
Vibration	MIL STD 810G: 514.6 C-II
Chemical resistance	MIL STD 810G
Drop test	Top, bottom, side. 3 times/orientation, 40"
Package drop	All faces & corners, 40"

Issue: 1907

In the effort to improve our products, we reserve the right to make changes judged to be necessary.

CONFIDENTIAL AND PROPRIETARY INFORMATION

This document contains confidential and proprietary information of Pulse Electronics, Inc. (Pulse) and is protected by copyright, trade secret and other state and federal laws. Its receipt or possession does not convey any rights to reproduce, disclose its contents, or to manufacture, use or sell anything it may describe. Reproduction, disclosure or use without specific written authorization of Pulse is strictly forbidden.

Description: In Building Public Safety
Antenna 132-174 / 380-570 / 700-960 MHz

Series: V-Thinity V/H/7/8

PART NUMBER: PSIBVU78 / PSIBVU78IP

MECHANICAL DRAWING

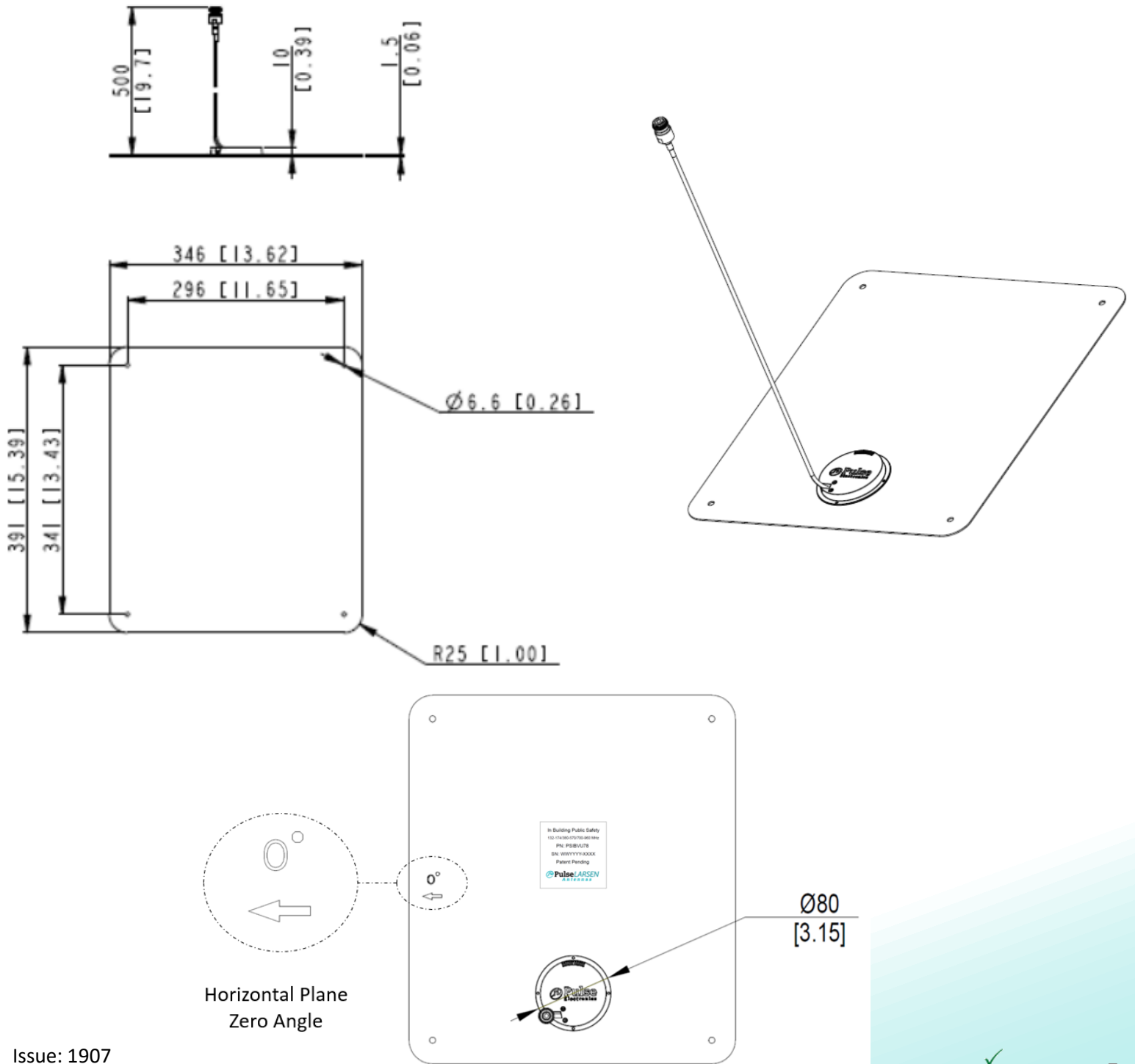

Issue: 1907

In the effort to improve our products, we reserve the right to make changes judged to be necessary.

CONFIDENTIAL AND PROPRIETARY INFORMATION

This document contains confidential and proprietary information of Pulse Electronics, Inc. (Pulse) and is protected by copyright, trade secret and other state and federal laws. Its receipt or possession does not convey any rights to reproduce, disclose its contents, or to manufacture, use or sell anything it may describe. Reproduction, disclosure or use without specific written authorization of Pulse is strictly forbidden.

Description: In Building Public Safety
Antenna 132-174 / 380-570 / 700-960 MHz

Series: V-Thinity V/H/7/8

PART NUMBER: PSIBVU78 / PSIBVU78IP

CHARTS – antenna mounted against ceiling tile with 2ft x 2ft metal suspension frame

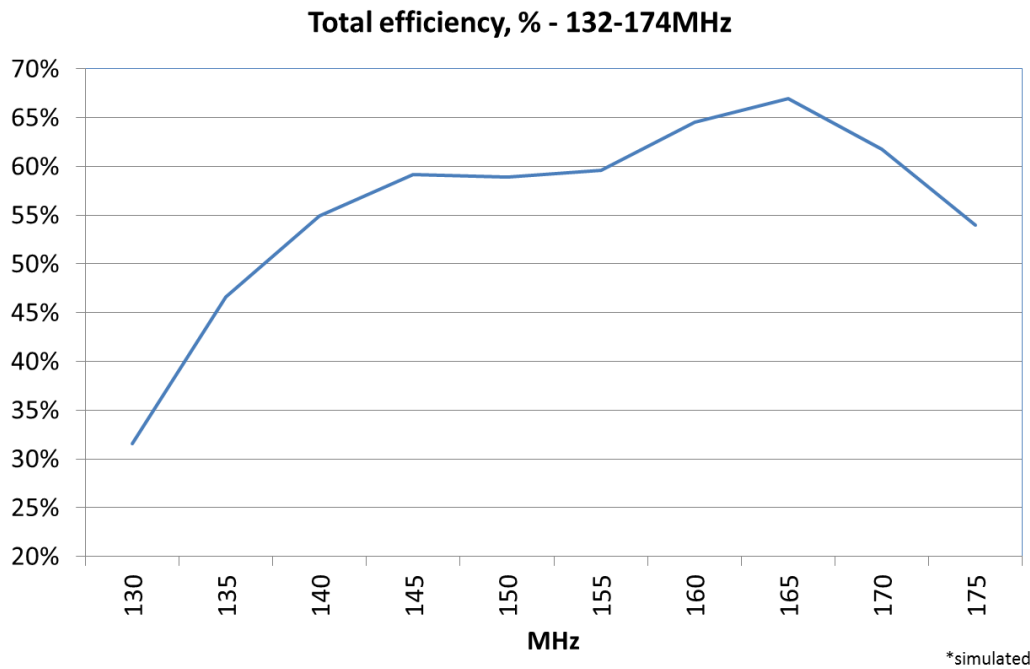
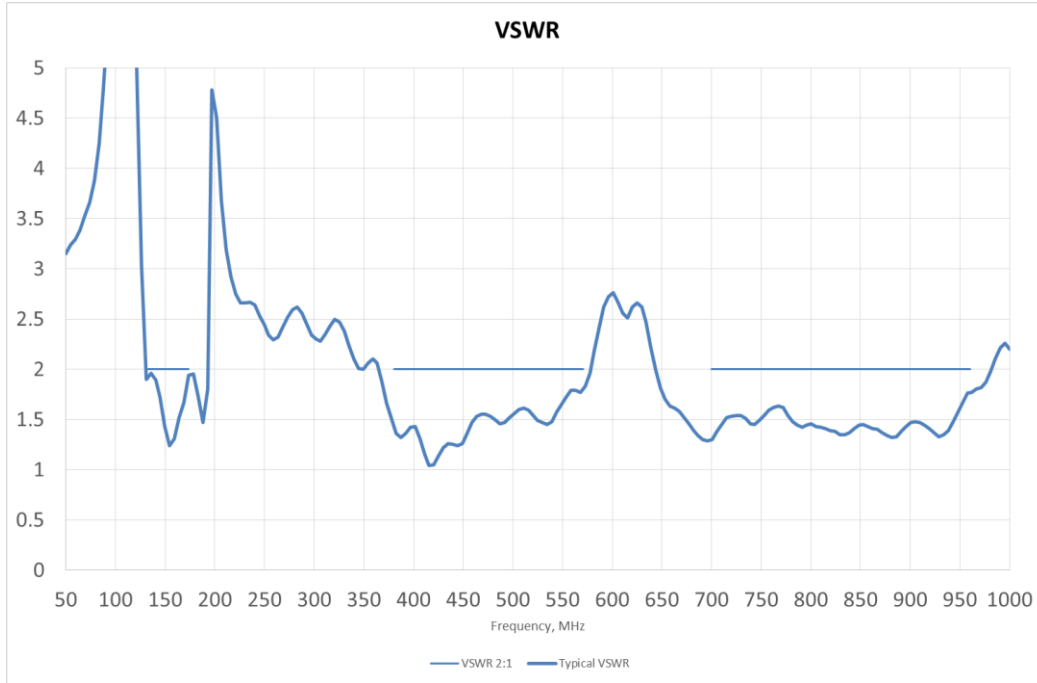

Issue: 1907

In the effort to improve our products, we reserve the right to make changes judged to be necessary.

CONFIDENTIAL AND PROPRIETARY INFORMATION

This document contains confidential and proprietary information of Pulse Electronics, Inc. (Pulse) and is protected by copyright, trade secret and other state and federal laws. Its receipt or possession does not convey any rights to reproduce, disclose its contents, or to manufacture, use or sell anything it may describe. Reproduction, disclosure or use without specific written authorization of Pulse is strictly forbidden.

Description: In Building Public Safety
Antenna 132-174 / 380-570 / 700-960 MHz

Series: V-Thinity V/H/7/8

PART NUMBER: PSIBVU78 / PSIBVU78IP

CHARTS – antenna mounted against ceiling tile with 2ft x 2ft metal suspension frame

Total efficiency, % - 380-570MHz

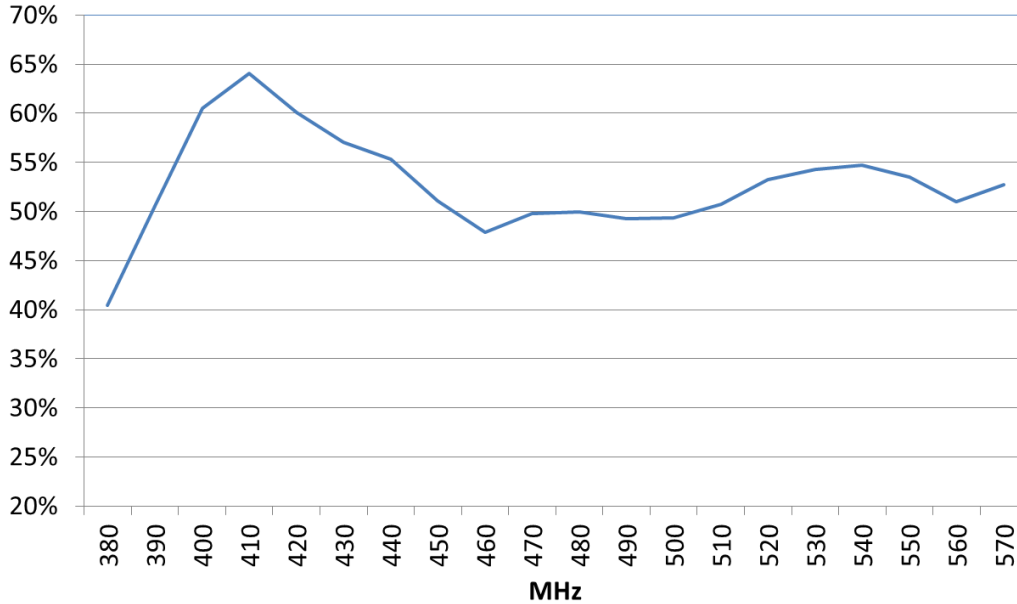

Total efficiency, % - 700-960MHz

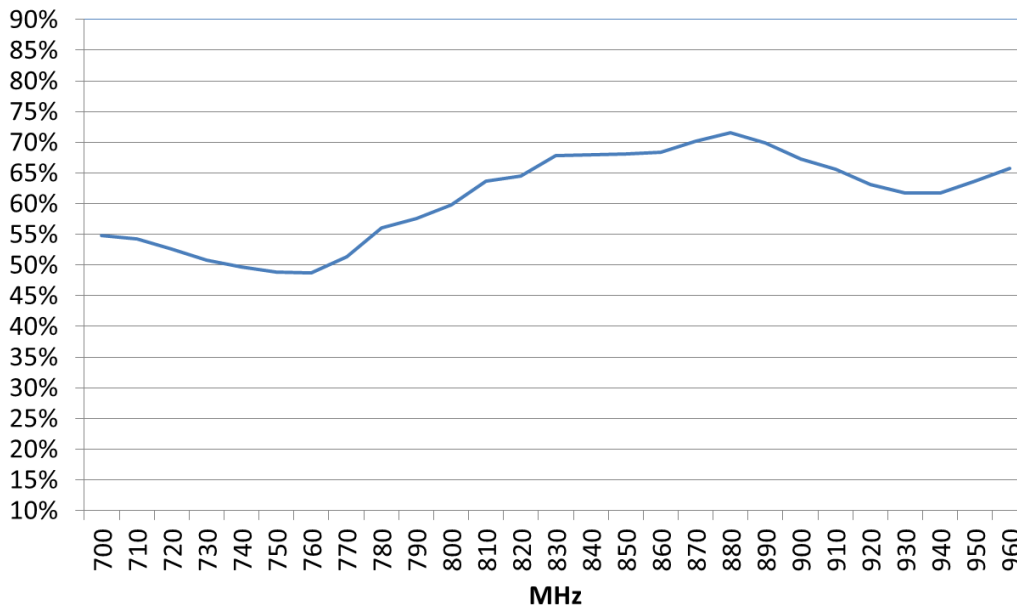

Issue: 1907

In the effort to improve our products, we reserve the right to make changes judged to be necessary.

CONFIDENTIAL AND PROPRIETARY INFORMATION

This document contains confidential and proprietary information of Pulse Electronics, Inc. (Pulse) and is protected by copyright, trade secret and other state and federal laws. Its receipt or possession does not convey any rights to reproduce, disclose its contents, or to manufacture, use or sell anything it may describe. Reproduction, disclosure or use without specific written authorization of Pulse is strictly forbidden.

Description: In Building Public Safety
 Antenna 132-174 / 380-570 / 700-960 MHz

Series: V-Thinity V/H/7/8

PART NUMBER: PSIBVU78 / PSIBVU78IP

CHARTS – antenna mounted against ceiling tile with 2ft x 2ft metal suspension frame

Vertical plane 132-174MHz

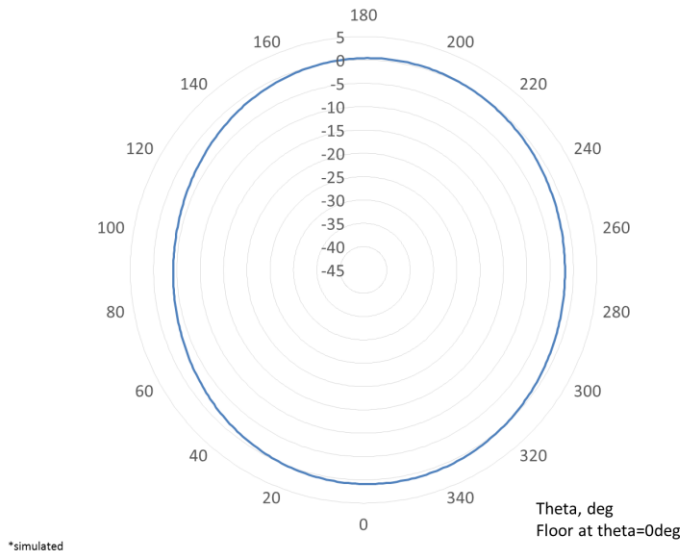

Horizontal plane 132-174MHz

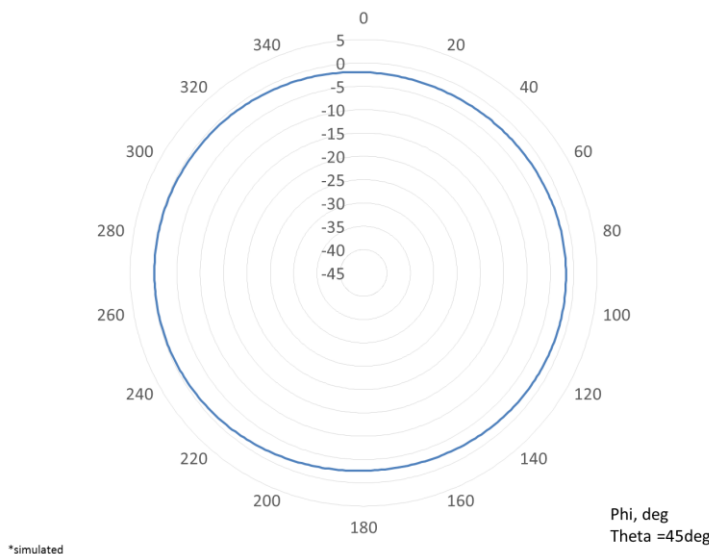

Issue: 1907

In the effort to improve our products, we reserve the right to make changes judged to be necessary.

CONFIDENTIAL AND PROPRIETARY INFORMATION

This document contains confidential and proprietary information of Pulse Electronics, Inc. (Pulse) and is protected by copyright, trade secret and other state and federal laws. Its receipt or possession does not convey any rights to reproduce, disclose its contents, or to manufacture, use or sell anything it may describe. Reproduction, disclosure or use without specific written authorization of Pulse is strictly forbidden.

Description: In Building Public Safety
 Antenna 132-174 / 380-570 / 700-960 MHz

Series: V-Thinity V/H/7/8

PART NUMBER: PSIBVU78 / PSIBVU78IP

CHARTS – antenna mounted against ceiling tile with 2ft x 2ft metal suspension frame

Vertical plane 380-570MHz

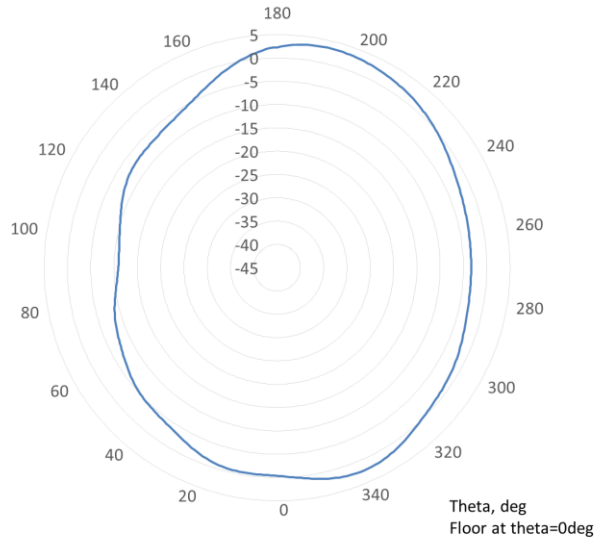

Horizontal plane 380-570MHz

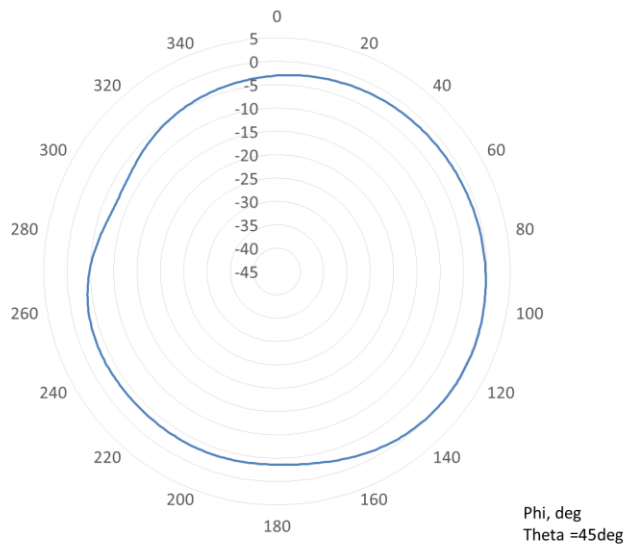

Issue: 1907

In the effort to improve our products, we reserve the right to make changes judged to be necessary.

CONFIDENTIAL AND PROPRIETARY INFORMATION

This document contains confidential and proprietary information of Pulse Electronics, Inc. (Pulse) and is protected by copyright, trade secret and other state and federal laws. Its receipt or possession does not convey any rights to reproduce, disclose its contents, or to manufacture, use or sell anything it may describe. Reproduction, disclosure or use without specific written authorization of Pulse is strictly forbidden.

Description: In Building Public Safety
 Antenna 132-174 / 380-570 / 700-960 MHz

Series: V-Thinity V/H/7/8

PART NUMBER: PSIBVU78 / PSIBVU78IP

CHARTS – antenna mounted against ceiling tile with 2ft x 2ft metal suspension frame

Vertical plane 700-960MHz

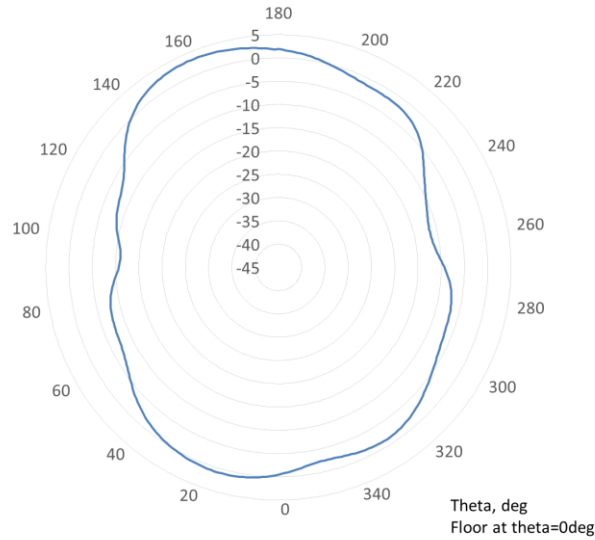

Horizontal plane 700-960MHz

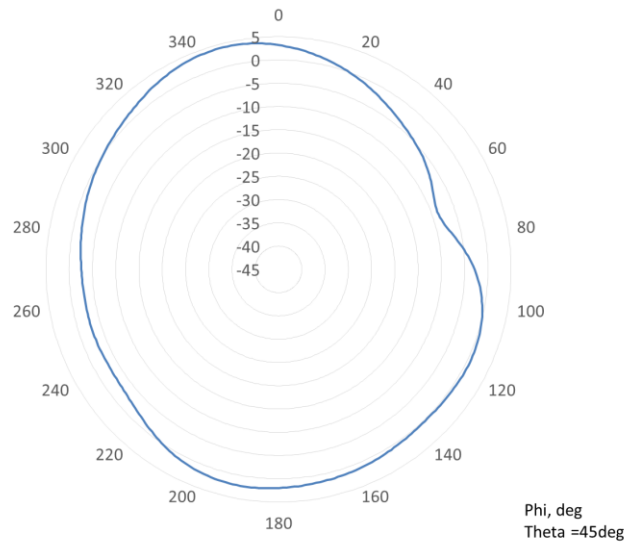

Issue: 1907

In the effort to improve our products, we reserve the right to make changes judged to be necessary.

CONFIDENTIAL AND PROPRIETARY INFORMATION

This document contains confidential and proprietary information of Pulse Electronics, Inc. (Pulse) and is protected by copyright, trade secret and other state and federal laws. Its receipt or possession does not convey any rights to reproduce, disclose its contents, or to manufacture, use or sell anything it may describe. Reproduction, disclosure or use without specific written authorization of Pulse is strictly forbidden.



Description: In Building Public Safety
Antenna 132-174 / 380-570 / 700-960 MHz

Series: V-Thinity V/H/7/8

PART NUMBER: PSIBVU78 / PSIBVU78IP

ASSEMBLY

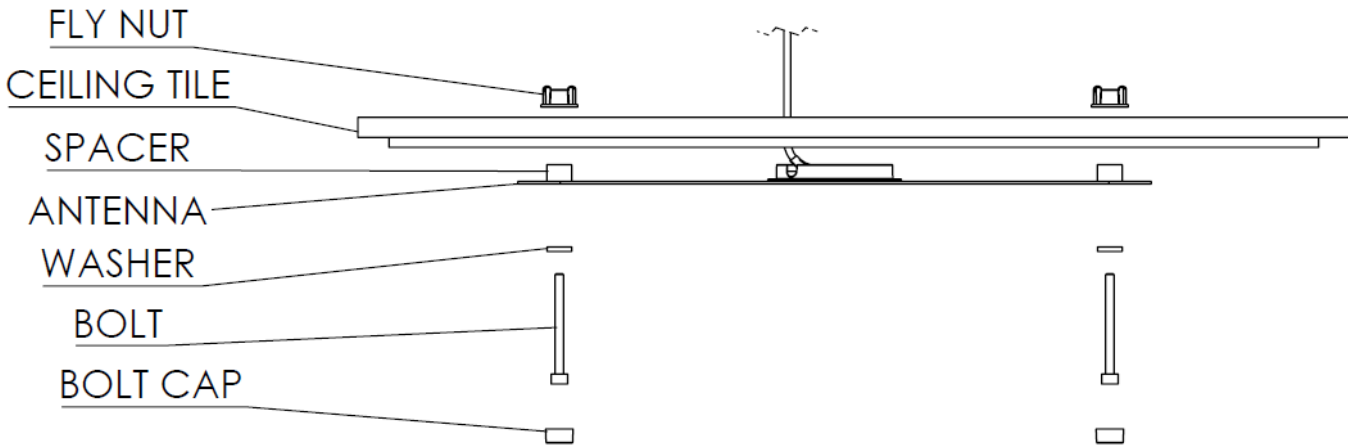
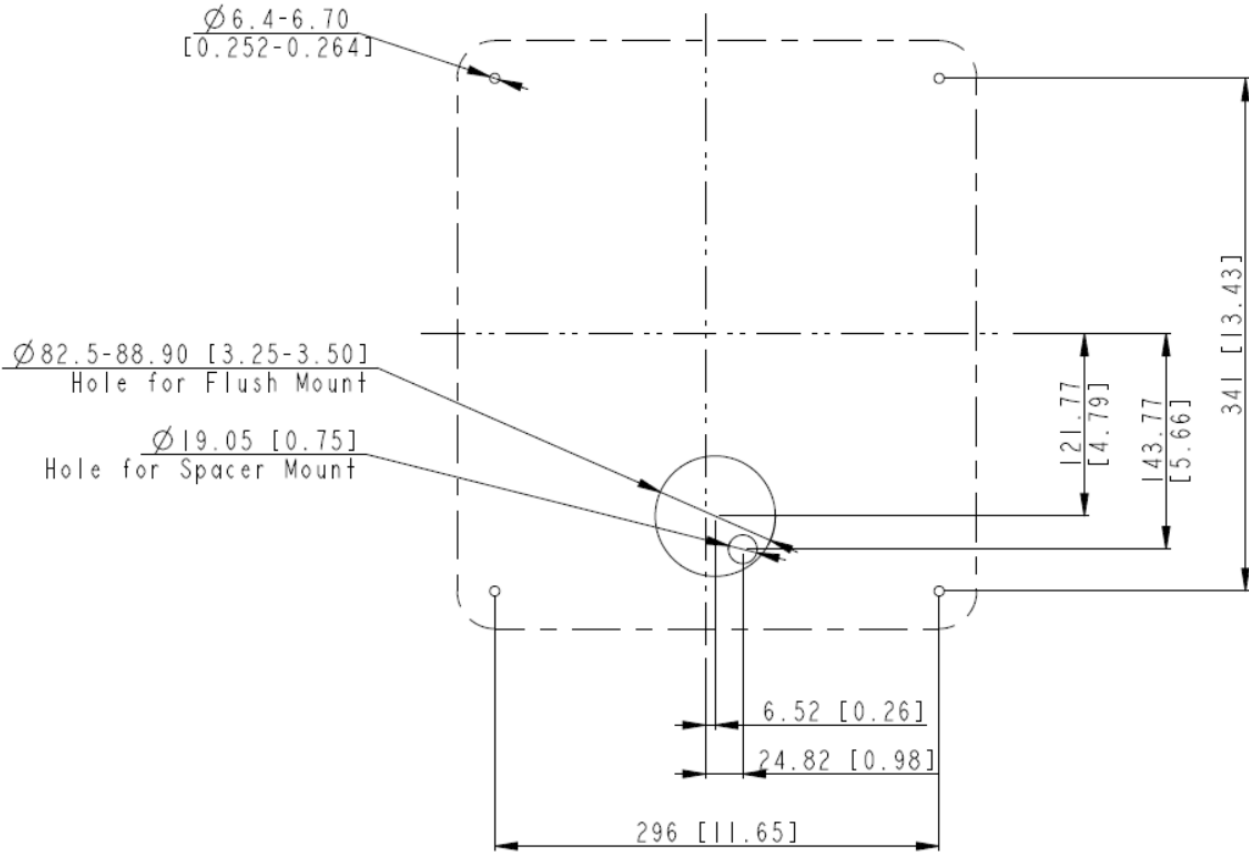

* Spacer to be used in gypsum & concrete installations

Issue: 1907

In the effort to improve our products, we reserve the right to make changes judged to be necessary.

CONFIDENTIAL AND PROPRIETARY INFORMATION

This document contains confidential and proprietary information of Pulse Electronics, Inc. (Pulse) and is protected by copyright, trade secret and other state and federal laws. Its receipt or possession does not convey any rights to reproduce, disclose its contents, or to manufacture, use or sell anything it may describe. Reproduction, disclosure or use without specific written authorization of Pulse is strictly forbidden.

Description: In Building Public Safety
Antenna 132-174 / 380-570 / 700-960 MHz

Series: V-Thinity V/H/7/8

PART NUMBER: PSIBVU78 / PSIBVU78IP

Packaging

- Each antenna packed in a plastic bag and a single box
- 1 label on each antenna with Part number, Description, Serial number, date code
- 34 single boxes of antennas packed in a master carton.
- 1 label on each carton with Qty, Part number, Date code.

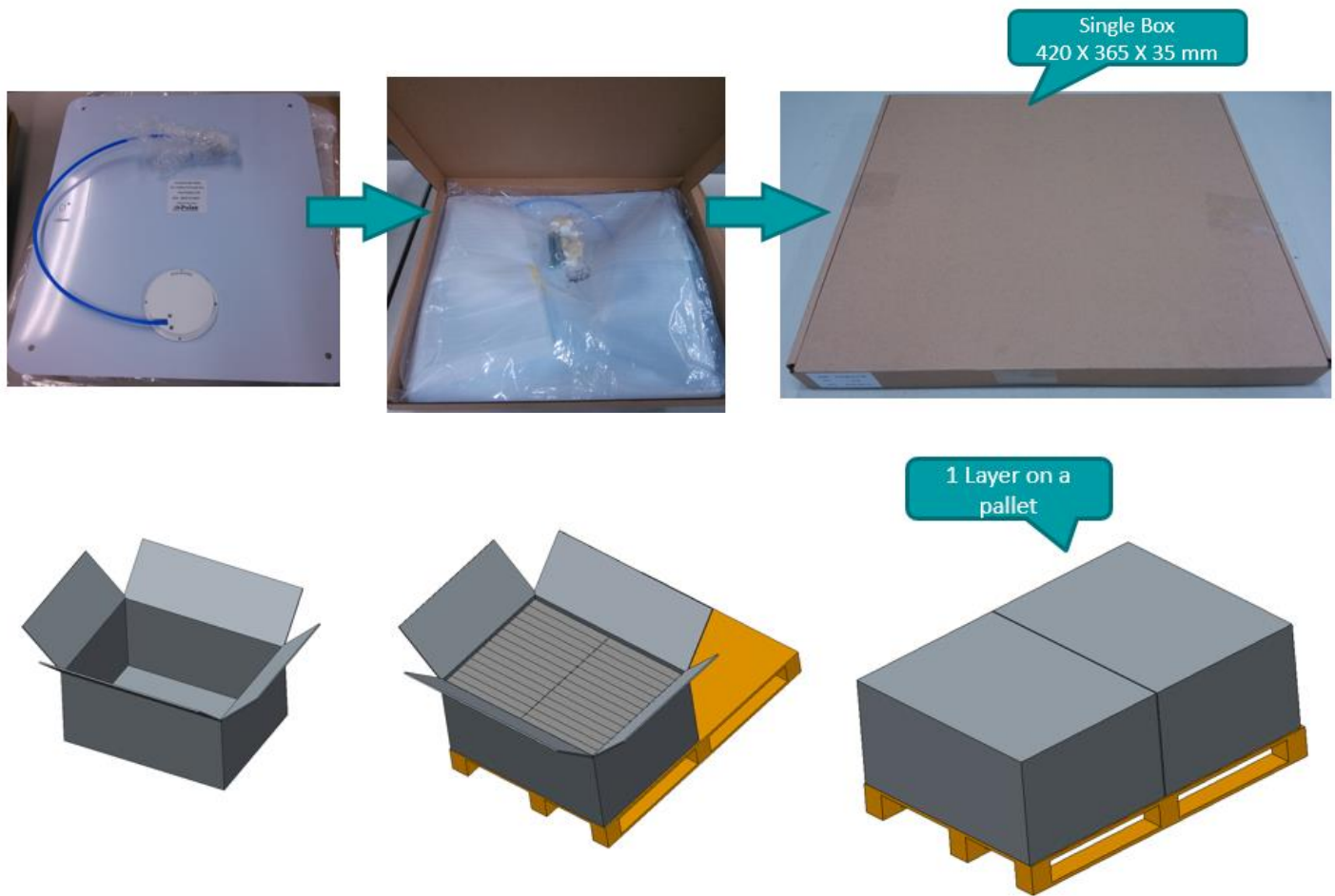

Issue: 1907

In the effort to improve our products, we reserve the right to make changes judged to be necessary.

CONFIDENTIAL AND PROPRIETARY INFORMATION

This document contains confidential and proprietary information of Pulse Electronics, Inc. (Pulse) and is protected by copyright, trade secret and other state and federal laws. Its receipt or possession does not convey any rights to reproduce, disclose its contents, or to manufacture, use or sell anything it may describe. Reproduction, disclosure or use without specific written authorization of Pulse is strictly forbidden.