



**RPE122C0G122J100V**  
MURATA MANUFACTURING

[Buy Now](#)



Looking for a discount?

[Check out our current promotions!](#)

Give us a call

**1-855-837-4225**

International: 1-415-281-3866

## Email Us

Sales and New Orders: [sales@verical.com](mailto:sales@verical.com)

Order Support: [support@verical.com](mailto:support@verical.com)

Suppliers: [Visit our seller page](#)

## Company Address

Arrow Electronics, Inc  
9201 East Dry Creek Road  
Centennial, CO 80112

# APPLICATION SPECIFIC CAPACITORS CATALOG

C-29-B

**muRata**  
*Innovator in Electronics*

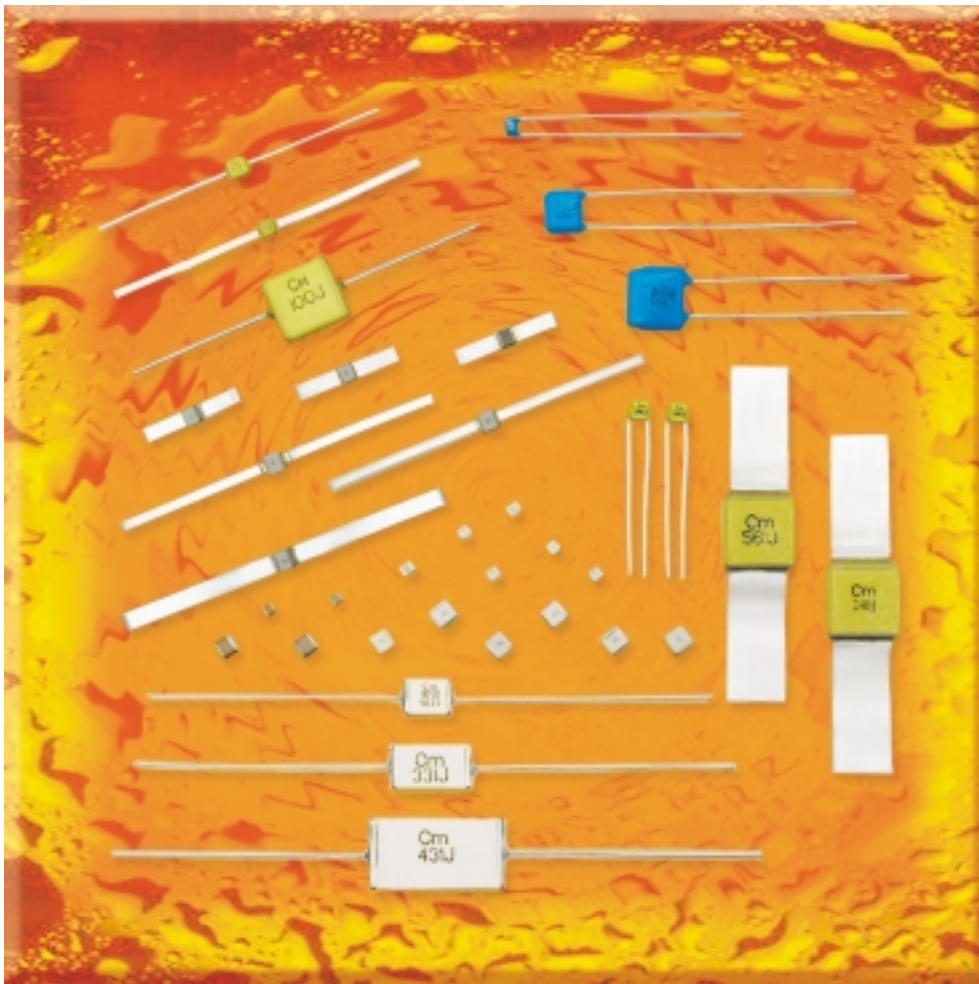

Please visit our website  
[www.murata.com](http://www.murata.com)

# CONTENTS

<b>US Manufacturing Process Guide</b> .....	1
<b>Glossary of Specialized Terms</b> .....	2
<b>1</b> MA/MB High Frequency Series Ceramic Capacitors .....	3-9
<b>2</b> High Q, K, UY Frequency Series Ceramic Capacitors.....	10-11
<b>3</b> UFP/UFN RF Power Capacitors .....	12-13
<b>4</b> High Q UV RF Power Capacitors .....	14
<b>5</b> RFE High Reliability Capacitors .....	15-16
<b>6</b> High Frequency, High Voltage Global Part Numbering System .....	17-18
<b>7</b> ERB* High Frequency Ceramic Capacitors .....	19-22
<b>8</b> 1kv* High Voltage Ceramic Capacitors .....	23
<b>9</b> Hkv* High Voltage Ceramic Capacitors .....	24

If you have any questions concerning Application Specific Capacitor Products, please contact your local Murata Sales Representative or authorized Murata distributor.

\*All the Part Numbers given in the text and specification tables of these product categories are “Global Part Numbers” that were adopted in June 2001. When referring to the contents of this catalog, please carefully review.

For your reference, “**Global Part Numbering**” is described on the first page of each section.

## Quality Control

Murata Electronics' Quality Control Department maintains product quality at a level equal to the company's high standards of performance and workmanship, which are certified to ISO-9001 requirements. The department is vested with the authority to exercise control over every phase of the manufacturing process. This control extends from incoming inspection of purchased material to in-process inspection, inspection of final product, packaging and shipping.

Many of today's demanding applications present unique capacitor requirements in order to meet application specific design objectives.

Murata Electronics meets these objectives by offering one of the world's largest varieties and capabilities of specialty capacitors for high reliability, high voltage, high frequency and undersea communication markets.

Whether your application calls for the MA/MB Series, ERB Series, High Voltage Series, special lead configurations, or other unique designs, you can rely on Murata's expertise to supply a reliable, repeatable product for all your needs.



## Hi-Reliability Test Methods

### Corporate QA Laboratory Test and Method List

This is a listing of the more frequent tests performed in the QA Lab. It is not a comprehensive list and there are many variations of these tests as well as with others that are not listed here.

**Barometric Pressure (Reduced):** EIA-198 Method 207 or MIL-STD-202 Method 105. Capable of 0 to 600 VDC, usually performed up to 100K feet at hot or cold temp.

**Bending Strength:** Chip Monolithic Ceramic Capacitor GRM Series Tech. Data Manual TD.No. C09E para. 4-3 includes Cap, DF and IR measurement while mounted on an FR4 board w/flex stress applied. Capable of 5mm board deflection.

**Break Strength:** Chip Monolithic Ceramic Capacitor GRM Series Tech. Data Manual TD.No. C09E para. 4-2 measurement in pounds or kg's of pressure recorded when chip capacitor breaks. 0 to 50 lb. Maximum.

**Capacitance:** EIA-198 Method 101 or MIL-STD-202 Method 305. Capable of MHz (10KHz to 10MHz) or KHz (100Hz to 100KHz).

**DF (Dissipation Factor):** EIA-198 Method 101 or MIL-STD-202 Method 305. Capable of MHz (10KHz to 10MHz) or KHz (100Hz to 100KHz).

**DWV (Dielectric Withstanding Voltage):** EIA-198 Method 103 or MIL-STD-202 Method 301, usually 2.5 X rated voltage. Capable of up to 25,000 VDC.

**ESR (Effective Series Resistance):** EIA-198 Method 106 and EIA-RS-483.

**HALT (Highly Accelerated Life Test):** EQA-0003 usually test until 60% fail. Capable of up to +200°C and 1000 VDC max.

**HAST (Highly Accelerated Stress Test):** EQA-0001 usually 1.5-2.5 VDC applied during pressure. Capable of 0 to 4 kgf/cm of steam pressure.

**HUMIDITY:** EIA-198 Method 202 Cond. "B" or MIL-STD-202 Method 103, 40°C @ 90 to 95 % R.H. (with no voltage) test duration usually 504 hours.

**IR (Insulation Resistance):** EIA-198 Method 104 or MIL-STD-202 Method 302. Resistance in ohms, capable of 0 to +150°C and 0 to 1000 VDC max.

**Immersion:** EIA-198 Method 203 or MIL-STD-202 Method 104, 15 minute cycles of hot/cold or saltwater w/post IR test.

**Life Test:** EIA-198 Method 210 Cond."C" or MIL-STD-202 Method 108, usually 1,000 or 2,000 hours @ rated temp. w/2X rated voltage. Capable of 0 to +150°C and 0 to 1000 VDC. Special Life chambers with capability of 0 to 25,000 VDC.

**Load Humidity:** MIL-PRF-55681 para. 4.8.15 (except w/1.5 vdc pulsed and post IR test) +85°C @ 85% R.H., usually 240 hours duration. Capable of 0-90°C and 0-98% R.H.

**Moisture Resistance:** EIA-198 Method 204 or MIL-STD-202 Method 106, cycle heat and humidity w/100 VDC applied or rated voltage, test duration usually 240 hours.

**Physical Dimensions:** As required by product specification.

**Q (Quality Factor):** EIA-198 Method 102 or MIL-STD-202 Method 306, a calculated measure of the energy storage factor.

**Resistance To Soldering Heat:** EIA-198 Method 302 or MIL-STD-202 Method 210, condition of test will vary w/termination type. Capable of up to +399°C.

**Resistance To Solvents:** EIA-198 Method 210 or MIL-STD-202 Method 215, only on marked parts.

**Resonance:** MIL-PRF-55681 para. 4.8.18, determines series resonant frequency.

**Salt Water Boil:** EQI-0054 part of the thermal shock (solder dip), usually one hour duration w/post IR test.

**Salt Spray:** MIL-STD-202 Method 101, environmental corrosion test.

**Shock, Specified Pulse (Half Sine or Sawtooth):** EIA-198 Method 305 or MIL-STD-202 Method 213. Capable of 2gs to 3000 g's and 0 to 2000 VDC.

**Solderability:** EIA-198 Method 301 or MIL-STD-202 Method 208, both methods require 8 hours of steam aging but EIA method allows RMA flux.

**Temperature Coefficient (TC):** EIA-198 Method 105 Cond. "B". Measurement of cap change over temperature range, usually done @ -55°C to rated temp. or as high as +125°C.

**Temperature Cycling:** Same as air to air thermal shock but w/ambient (+25°C) between extremes, range can be as much as -100°C to +200°C.

**Terminal Strength:** EIA-198 Method 303 or MIL-STD-202 Method 211, pull or shear as measured in pounds or kg's.

## Hi-Reliability Test Methods

**Thermal Shock:** EIA-198 Method 202 Cond. "B" or MIL-STD-202 Method 107, usually air to air w/majority done at -55°C and +125°C but we are capable of -70°C to + 185°C with unlimited cycles. The other type of thermal shock is a solder dip w/post IR test, the solder temp. can range from +260°C to +399°C.

**Vibration (Sine or Random):** EIA-198 Method 304 or MIL-STD-202 Method 204 or 214. Capable of 0 to 2000 VDC, 0-5000 hz and 2g's to 60g's.

**Voltage T.C.:** MIL-PRF-55681 para. 4.8.11 for T.C. and drift, para. 3.14 for Volt. Temp. limits. Same as Temperature Coefficient (TC) except with rated voltage applied.

Other infrequent or special testing is done on an as needed basis utilizing the individual specifications or test methods.

## Glossary of Specialized Terms

### 1. DIELECTRIC:

Sometimes called "Insulator", a dielectric is a material whose internal charges are bound and can therefore only move over atomic dimensions. It separates the conductive capacitor plates and is important in determining temperature characteristics, voltage rating, capacity/volume and other characteristics of a capacitor.

### 2. DISSIPATION FACTOR ("DF"):

The dissipation factor of an insulating material is defined as the ratio of energy dissipated to energy stored in the dielectric. The DF is frequency sensitive and must be specified at a given frequency.

### 3. QUALITY FACTOR ("Q"):

The Q factor is the ratio of energy stored to energy dissipated and is therefore often taken as the inverse of the DF at low frequency. Sometimes called "Figure of Merit," Q factors must be specified at a given frequency.

### 4. WORKING (OR "RATED") VOLTAGE:

Nominal continuous voltage which may be applied to a component with no derating of any kind.

### 5. DIELECTRIC WITHSTANDING VOLTAGE:

The peak voltage which the component is designed to withstand without damage for short periods of time. This value must be specified in terms of frequency, waveform, and time.

### 6. INSULATION RESISTANCE (MEGOHMS):

I.R. is the terminal to terminal DC resistance of a capacitor, and must be specified in terms of voltage, temperature, and relative humidity.

### 7. TEMPERATURE COEFFICIENT ("TC"):

"TC" is the decimal change in capacity per degree change in environmental temperature. The standard definition for "TC" in parts per million per degree centigrade is ...

$$TC = \frac{(Cx - Co)}{Co} \times \frac{(10^6)}{(Tx - To)} / ^\circ C$$

Where "Tx" is the test temperature, "To" is the reference temperature - usually 25°C. "Co" is the capacity measured at the reference temperature and "Cx" is the capacity measured at the test temperature.

### 8. DRIFT:

The extent in pF or % to which capacitor changes value as a result of temperature exposure. Sometimes called "Retrace", this measurement is usually made under nominal (i.e. room) conditions and both before and after the conclusion of temperature excursion. (Note: "Drift" may occasionally be used in the test context of the simple passage of time).

### 9. VOLTAGE COEFFICIENT:

All high K dielectrics tend to reduce their dielectric coefficient (capacity) in the presence of strong unidirectional electric fields. For some materials, and package designs, this effect can become very dramatic. Lower K materials do not exhibit a similar phenomenon. (Usually specified in pF/volt).

### 10. TERMINATION:

This term refers to the material and/or geometry of the terminals of the capacitor.

### 11. CHIP, MONOLITHIC OR MULTI-LAYER CAPACITOR:

All of these terms, and any combination of them, refer to a ceramic capacitor style which consists of alternate layers of ceramics and conductive (metallic) surfaces which are compressed and vitrified to form a single "monolithic" structure. Alternate metallic surfaces are then interconnected to form a two terminal capacitor.

### 12. ESR:

The sum of the equivalent series resistances of the electrode resistance and loss tangent of the dielectric, otherwise known as the real part of the capacitors equivalent circuit impedance (Note: The dielectric loss tangent is frequency dependent as is ESR).

### 13. AGING:

Aging is the change in the dielectric constant as a function of time. Aging is particularly noticeable in high dielectric materials and is measured as a percentage change per decade of time. Aging decreases logarithmically and becomes less apparent with time.

### 14. RF POWER:

Typically measured in KVA (applied power) for signals with frequencies greater than 1 MHz. RF Power is limited by the maximum rated voltage or the maximum power the capacitor is able to dissipate.

### 15. KVAR RATING:

Capacitive reactive power, determined by the rated RF voltage or the rated RF current and the equation  $KVAR = I \sin \theta$  where  $\theta$  is the phase between current and voltage.

## High Frequency Ceramic Capacitors

MA/MB Series



### OUTSTANDING CHARACTERISTICS

- Miniature size
- Very high Q at high frequencies
- High RF power capabilities
- Impervious to environmental conditions
- Low dissipation factors
- Excellent retrace capability (not applicable for X7R styles)
- High temperature stability
- Low noise
- Meets Mil-PRF-55681 with respect to: Moisture Resistance, Solderability, Low Voltage Humidity, Life Tests

### ADDITIONAL FEATURES

- Packaging options
- Lot processing data available

### MA SERIES

For filtering, coupling and impedance matching in most RF circuits, the MA Series chips and leaded devices offer outstanding performance and reliability with the greatest range of values and configurations. MA Series capacitors can be supplied with military equivalent screening. Please consult our factory.

MA Series ceramic fixed capacitors are miniature, high performance precision components having extremely high Q and high power capabilities from low frequencies to gigahertz ranges. These "low loss" multilayer capacitors are extremely stable with respect to variations in temperature, voltage and frequency.

MA Series capacitors are designed for miniature state-of-the-art circuit applications. They are small, easy to apply

and have excellent reliability. Units are available in ultra-miniature case size 1 (1.4 x 1.4 x 1.4mm) or miniature case size 2 (2.8 x 2.8 x 2.5mm). Standard case size 1 units are available as chips. Standard case size 2 units are available as chips and also in leaded configurations.

Clean-room manufacturing technology assures product reliability and automated processing reduces costs and cycle time. Key stages of the operation are monitored and controlled with the latest SPC techniques. Flexibility in design allows the production of non-standard values, while maintaining consistent quality objectives.

Please contact the factory for availability of special configurations or high-reliability screening.

### PART NUMBERING SYSTEM – CASE SIZE 1 & CASE SIZE 2

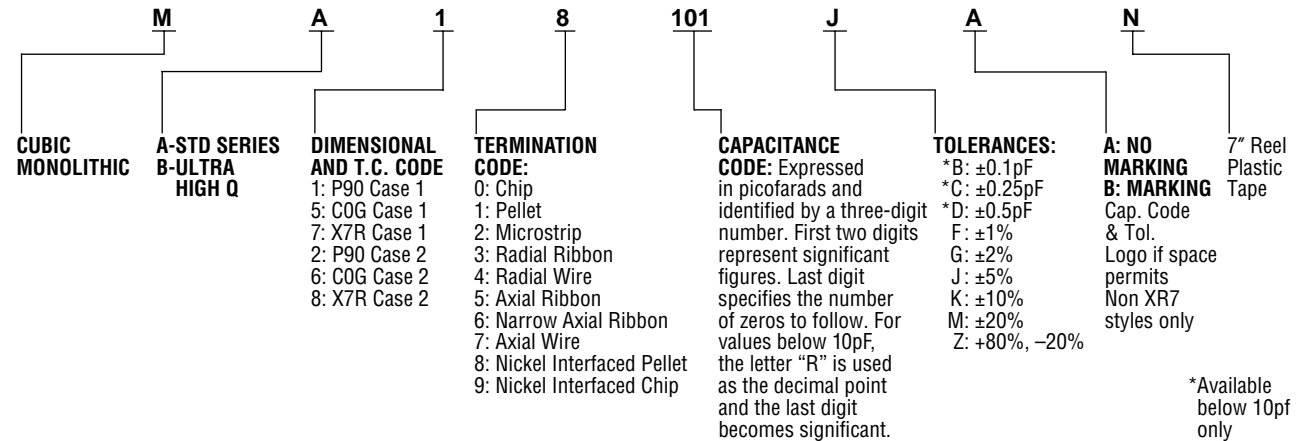

### SPECIAL LEAD CONFIGURATION FOR FLEX BOARDS

**NOTE:** Targeted for flex circuit boards, the MA22-6 version of the MA22 has an upraised lead configuration. The lead bends when flexing the board after assembly so that minimal stress is placed on the component.

Style	Type				Configuration	Dimensions: mm				Termination
	P90 ± 20	P90 ± 30	COG	X7R		L ± 0.38*	W ± 0.38*	T ± .038	Band Y	
Raised Micro-Strip	MA22-6	MB22-6	MA62-6	MA82-6		3.4	2.8	2.8	0.38 ± .25	Silver Ribbon: Length: 6.35 typical Width: 2.3 ± .13 Thickness: 0.1 ± .05

## High Frequency Ceramic Capacitors

MA/MB Series

1

### DIMENSIONS

Fig. 1 Chip

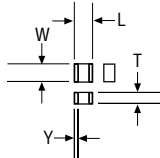

Fig. 2 Pellet

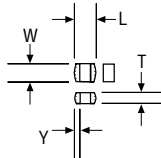

Fig. 3 Micro-Strip

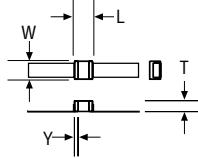

Fig. 4 Radial Ribbon

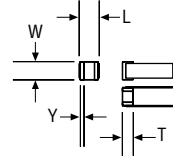

Fig. 5 Radial Wire

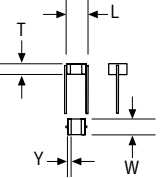

Fig. 6 Axial Ribbon

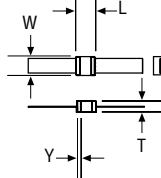

Fig. 7 Narrow Axial Ribbon

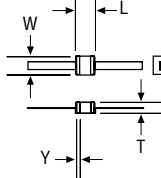
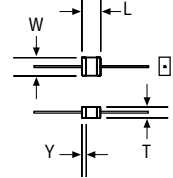

Fig. 8 Axial Wire



### CONFIGURATION AND DIMENSIONS – MA & MB

Style	Type				Figure	Case Size	Configuration	Dimensions: mm			Band Y	Termination Non-magnetic
	P90 ± 20	P90 ± 30	C0G	X7R				L ± 0.38*	W ± 0.38*	T max.		
Chip	MA10	—	MA50	MA70	1	1 EIA Style 0505		1.4 ± .25	1.4 ± .25	1.4	0.25 ± .1	Palladium Silver
Pellet	MA11	—	MA51	MA71	2			1.8 max.				Palladium Silver & Sn62 Solder
Nickel Interfaced Pellet	MA18	—	MA58	—	2							Palladium Silver, Nickel Interface** & Sn62 Solder
Nickel Interfaced Chip	MA19	—	MA59	MA79	1			1.4 ± .25				Palladium Silver, Nickel Interface** & Tin Plating
Chip	MA20	MB20	MA60	MA80	1	2 EIA Style 1010		2.8	2.8	2.5	0.38 ± .25	Palladium Silver
Pellet	MA21	MB21	MA61	MA81	2			3.3 max.				Palladium Silver, & Sn62 Solder
Micro Strip	MA22	MB22	MA62	MA82	3			3.4				Silver Ribbon: 6.35 x 2.3 x 0.1mm
Radial Ribbon	MA23	MB23	MA63	MA83	4			3.4				Silver Ribbon: 6.35 x 2.3 x 0.1mm
Radial Wire	MA24	MB24	MA64	MA84	5			3.8				#26AWG Silver Wire: 12.7 x 0.4mm Dia.
Axial Ribbon	MA25	MB25	MA65	MA85	6			3.4				Silver Ribbon: 6.35 x 2.3 x 0.1mm
Narrow Axial Ribbon	MA26	MB26	MA66	MA86	7			3.4				Silver Ribbon: 6.35 x 1.25 x 0.1mm
Axial Wire	MA27	MB27	MA67	MA87	8			3.8				#26AWG Silver Wire: 12.7 x 0.4mm Dia.
Nickel Interfaced Pellet	MA28	MB28	MA68	—	2			3.3 max.				Palladium Silver, Nickel Interface** & Sn62 Solder
Nickel Interfaced Chip	MA29	MB29	MA69	MA89	1		2.8	Palladium Silver, Nickel Interface** & Tin Plating				

\*Except where Tolerance is shown. Lead lengths are typical widths ±0.1mm, thickness & dia. ±0.05mm. All leaded parts are bonded with high temperature solder 748°F/298°C.

\*\*Magnetic construction due to nickel interface.

# Application Specific Capacitors

## Miniature Microwave Ceramic Capacitors

### MA Case Size 1 Series

#### MA10 & 50 SERIES, P90 & C0G – CASE SIZE 1

Cap. Code	Cap. pF	Cap. Tol.	WVDC	Cap. Code	Cap. pF	Cap. Tol.	WVDC	Cap. Code	Cap. pF	Cap. Tol.	WVDC
0R1	0.1	B	150	4R7	4.7	B,C,D	150	680	68	F,G,J,K,M	150
0R2	0.2	"	150	5R1	5.1	"	150	750	75	"	150
0R3	0.3	B,C	150	5R6	5.6	"	150	820	82	"	150
0R4	0.4	"	150	6R2	6.2	"	150	910	91	"	150
0R5	0.5	B,C,D	150	6R8	6.8	B,C,J,K,M	150	101	100	"	150
0R6	0.6	"	150	7R5	7.5	"	150	111*	110	"	50
0R7	0.7	"	150	8R2	8.2	"	150	121*	120	"	50
0R8	0.8	"	150	9R1	9.1	"	150	131*	130	"	50
0R9	0.9	"	150	100	10	F,G,J,K,M	150	151*	150	"	50
1R0	1.0	"	150	110	11	"	150	161*	160	"	50
1R1	1.1	"	150	120	12	"	150	181*	180	"	50
1R2	1.2	"	150	130	13	"	150	201*	200	"	50
1R3	1.3	"	150	150	15	"	150	221*	220	"	50
1R4	1.4	"	150	160	16	"	150	241*	240	"	50
1R5	1.5	"	150	180	18	"	150	271*	270	"	50
1R6	1.6	"	150	200	20	"	150	301*	300	"	50
1R7	1.7	"	150	220	22	"	150	331*	330	"	50
1R8	1.8	"	150	240	24	"	150	361*	360	"	50
1R9	1.9	"	150	270	27	"	150	391*	390	"	50
2R0	2.0	"	150	300	30	"	150	431*	430	"	50
2R2	2.2	"	150	330	33	"	150	471*	470	"	50
2R4	2.4	"	150	360	36	"	150	511*	510	"	50
2R7	2.7	"	150	390	39	"	150	561*	560	"	50
3R0	3.0	"	150	430	43	"	150	621*	620	"	50
3R3	3.3	"	150	470	47	"	150	681*	680	"	50
3R6	3.6	"	150	510	51	"	150	751*	750	"	50
3R9	3.9	"	150	560	56	"	150	821*	820	"	50
4R3	4.3	"	150	620	62	"	150	911*	910	"	50
								102*	1000	"	50

\*Extended Cap Range, C0G only

#### MA70 SERIES, X7R – CASE SIZE 1

Cap. Code	Cap. pF	Cap. Tol.	WVDC	Cap. Code	Cap. pF	Cap. Tol.	WVDC	Cap. Code	Cap. pF	Cap. Tol.	WVDC
511	510	K,M,Z	50	152	1500	K,M,Z	50	432	4300	K,M,Z	50
561	560	"	50	162	1600	"	50	472	4700	"	50
621	620	"	50	182	1800	"	50	512	5100	"	50
681	680	"	50	202	2000	"	50	562	5600	"	50
751	750	"	50	222	2200	"	50	622	6200	"	50
821	820	"	50	242	2400	"	50	682	6800	"	50
911	910	"	50	272	2700	"	50	752	7500	"	50
102	1000	"	50	302	3000	"	50	822	8200	"	50
112	1100	"	50	332	3300	"	50	912	9100	"	50
122	1200	"	50	362	3600	"	50	103	10000	"	50
132	1300	"	50	392	3900	"	50				

# Application Specific Capacitors

## Miniature Microwave Ceramic Capacitors

MA Case Size 2 Series

1

### MA20 & 60 SERIES, P90 & COG – CASE SIZE 2

Cap. Code	Cap. pF	Cap. Tol.	WVDC	Cap. Code	Cap. pF	Cap. Tol.	WVDC	Cap. Code	Cap. pF	Cap. Tol.	WVDC
0R1	0.1	B	500	7R5	7.5	"	500	201	200	"	300
0R2	0.2	"	500	8R2	8.2	B,C,J,K,M	500	221	220	"	200
0R3	0.3	B,C	500	9R1	9.1	"	500	241	240	F,G,J,K,M	200
0R4	0.4	"	500	100	10	F,G,J,K,M	500	271	270	"	200
0R5	0.5	B,C,D	500	110	11	"	500	301	300	"	200
0R6	0.6	"	500	120	12	"	500	331	330	"	200
0R7	0.7	"	500	130	13	"	500	361	360	"	200
0R8	0.8	"	500	150	15	"	500	391	390	"	200
0R9	0.9	"	500	160	16	"	500	431	430	"	200
1R0	1.0	"	500	180	18	"	500	471	470	"	200
1R1	1.1	"	500	200	20	"	500	511	510	"	100
1R2	1.2	"	500	220	22	"	500	561	560	"	100
1R3	1.3	"	500	240	24	"	500	621	620	"	100
1R4	1.4	"	500	270	27	"	500	681	680	"	50
1R5	1.5	"	500	300	30	"	500	751	750	"	50
1R6	1.6	"	500	330	33	"	500	821	820	"	50
1R7	1.7	"	500	360	36	"	500	911	910	"	50
1R8	1.8	"	500	390	39	"	500	102	1000	"	50
1R9	1.9	"	500	430	43	"	500	112*	1100	"	50
2R0	2.0	"	500	470	47	"	500	122*	1200	"	50
2R1	2.1	"	500	510	51	"	500	132*	1300	"	50
2R2	2.2	"	500	560	56	"	500	152*	1500	"	50
2R4	2.4	"	500	620	62	"	500	162*	1600	"	50
2R7	2.7	"	500	680	68	"	500	182*	1800	"	50
3R0	3.0	"	500	750	75	"	500	202*	2000	"	50
3R3	3.3	"	500	820	82	"	500	222*	2200	"	50
3R6	3.6	"	500	910	91	"	500	242*	2400	"	50
3R9	3.9	"	500	101	100	"	500	272*	2700	"	50
4R3	4.3	"	500	111	110	"	300	302*	3000	"	50
4R7	4.7	"	500	121	120	"	300	332*	3300	"	50
5R1	5.1	"	500	131	130	"	300	362*	3600	"	50
5R6	5.6	"	500	151	150	"	300	392*	3900	"	50
6R2	6.2	"	500	161	160	"	300	432*	4300	"	50
6R8	6.8	B,C,J,K,M	500	181	180	"	300	472*	4700	"	50
								512*	5200	"	50

Note: Limited capacitance range available in 1Kv; consult factory.

\*Extended Cap Range, COG only

### MA80 SERIES, X7R – CASE SIZE 2

Cap. Code	Cap. pF	Cap. Tol.	WVDC	Cap. Code	Cap. pF	Cap. Tol.	WVDC	Cap. Code	Cap. pF	Cap. Tol.	WVDC
512	5100	K,M,Z	100	153	15000	K,M,Z	100	433	43000	K,M,Z	100
562	5600	"	100	163	16000	"	100	473	47000	"	100
622	6200	"	100	183	18000	"	100	513	51000	"	100
682	6800	"	100	203	20000	"	100	563	56000	"	100
752	7500	"	100	223	22000	"	100	623	62000	"	100
822	8200	"	100	243	24000	"	100	683	68000	"	100
912	9100	"	100	273	27000	"	100	753	75000	"	100
103	10000	"	100	303	30000	"	100	823	82000	"	100
113	11000	"	100	333	33000	"	100	913	91000	"	100
123	12000	"	100	363	36000	"	100	104	100000	"	100
133	13000	"	100	393	39000	"	100				

## Miniature Microwave Ceramic Capacitors

MB, P90, Case Size 2

### MB20 ~ 29 SERIES, P90 ± 30 – CASE SIZE 2

Cap. Code	Cap. pF	Cap. Tol.	WVDC	Cap. Code	Cap. pF	Cap. Tol.	WVDC	Cap. Code	Cap. pF	Cap. Tol.	WVDC
0R4	0.4	B,C	1000	3R0	3.0	"	1000	200	20	"	500
0R5	0.5	B,C,D	1000	3R3	3.3	"	1000	220	22	"	500
0R6	0.6	"	1000	3R6	3.6	"	1000	240	24	"	500
0R7	0.7	"	1000	3R9	3.9	"	1000	270	27	"	500
0R8	0.8	"	1000	4R3	4.3	B,C,D	1000	300	30	"	500
0R9	0.9	"	1000	4R7	4.7	"	1000	330	33	"	500
1R0	1.0	"	1000	5R1	5.1	"	1000	360	36	"	500
1R1	1.1	"	1000	5R6	5.6	"	1000	390	39	"	500
1R2	1.2	"	1000	6R2	6.2	"	1000	430	43	"	500
1R3	1.3	"	1000	6R8	6.8	B,C,J,K,M	1000	470	47	F,G,J,K,M	300
1R4	1.4	"	1000	7R5	7.5	"	1000	510	51	"	300
1R5	1.5	"	1000	8R2	8.2	"	1000	560	56	"	300
1R6	1.6	"	1000	9R1	9.1	"	1000	620	62	"	300
1R7	1.7	"	1000	100	10	F,G,J,K,M	500	680	68	"	100
1R8	1.8	"	1000	110	11	"	500	750	75	"	100
1R9	1.9	"	1000	120	12	"	500	820	82	"	100
2R0	2.0	"	1000	130	13	"	500	910	91	"	100
2R1	2.1	"	1000	150	15	"	500	101	100	"	100
2R2	2.2	"	1000	160	16	"	500				
2R4	2.4	"	1000	180	18	"	500				
2R7	2.7	"	1000								

## Design Engineering Kits

MA Series



- Miniature sizes
- Very high Q at high frequencies
- High RF power capabilities
- Impervious to adverse environmental conditions
- Low dissipation factors
- Perfect retrace capability
- High temperature stability
- Low noise

### CASE 1 SIZE KIT

Kit-MA58-A	QTY
MA581R0B	5
MA581R5C	5
MA582R2C	5
MA583R3C	5
MA584R7C	5
MA586R8D	5
MA58100J	5
MA58150J	5
MA58220J	5
MA58330J	5
MA58470J	5
MA58680J	5
MA58101K	5
MA58221K	5
MA58471K	5
MA58102K	5

### CASE 2 SIZE KIT

Kit-MA28-A	QTY
MA280R3B	5
MA2800R5B	5
MA2800R7B	5
MA2801R0B	5
MA2801R2C	5
MA2801R5C	5
MA2801R8C	5
MA2802R2C	5
MA2802R7C	5
MA2803R3C	5
MA2803R9C	5
MA2804R7C	5
MA2805R6D	5
MA2806R8D	5
MA2808R2D	5

### CASE 2 SIZE KIT (continued)

Kit-MA28-A	QTY
MA280100J	5
MA280120J	5
MA280150J	5
MA280180J	5
MA280220J	5
MA280270J	5
MA280330J	5
MA280390J	5
MA280470J	5
MA280560J	5
MA280680J	5
MA280820J	5
MA280101K	5
MA280151K	5
MA280221K	5
MA280331K	5
MA280471K	5
MA280681K	5
MA280102K	5

### CASE 2 SIZE KIT

Kit-MA68-A	QTY
MA681R0B	5
MA681R5C	5
MA682R2C	5
MA683R3C	5
MA684R7C	5
MA686R8D	5
MA68100J	5
MA68150J	5
MA68220J	5
MA68330J	5
MA68470J	5
MA68680J	5
MA68101K	5
MA68221K	5
MA68471K	5
MA68102K	5
MA68222K	5
MA68472K	5
MA68512K	5

### CASE 1 SIZE KIT

Kit-MA18-A	QTY
MA180R3B	5
MA180R5B	5
MA180R7B	5
MA181R0B	5
MA181R2C	5
MA181R5C	5
MA181R8C	5
MA182R2C	5
MA182R7C	5
MA183R3C	5
MA183R9C	5
MA184R7C	5
MA185R6D	5
MA186R8D	5
MA188R2D	5
MA18100J	5
MA18120J	5
MA18150J	5
MA18180J	5
MA18220J	5
MA18270J	5
MA18330J	5
MA18390J	5
MA18470J	5
MA18560J	5
MA18680J	5
MA18820J	5
MA18101K	5

## ATC Cross Reference

MA/UFP Series

1

ATC P/N	MURATA P/N
<b>MA SERIES: P90 ± 20 PPM/°C</b>	
ATC100A----W--	None, Solder Plated Terminations
ATC100A----C--	MA10
ATC100A----CN--	MA10
ATC100A----CA--	None, Gold Terminations
ATC100A----P--	MA1 8
ATC100B----W--	None, Solder Plated Terminations
ATC100B----WN--	None, Copper Barrier Solder Plated
ATC100B----PN--	None, Copper Barrier Solder Coated
ATC100B----C--	MA20
ATC100B----CA--	None, Gold Terminations
ATC100B----MS--	MA22
ATC100B----MN--	MA22
ATC100B----RR--	MA23
ATC100B----FN--	MA23
ATC100B----RW--	MA24
ATC100B----RN--	MA24
ATC100B----AR--	MA25
ATC100B----NAR--	MA26
ATC100B----AN--	MA26
ATC100B----AW--	MA27
ATC100B----BN--	MA27
ATC100B----P--	MA28

ATC P/N	MURATA P/N
<b>MA SERIES: 0 ± 30 PPM/°C</b>	
ATC700A----W--	None, Solder Plated Terminations
ATC700A----C--	MA50
ATC700A----CN--	MA50
ATC700A----CA--	None, Gold Terminations
ATC700A----P--	MA58
ATC700B----W--	None, Solder Plated Terminations
ATC700B----WN--	None, Copper Barrier Solder Plated
ATC700B----PN--	None, Copper Barrier Solder Coated
ATC700B----C--	MA60
ATC700B----CA--	None, Gold Terminations
ATC700B----MS--	MA62
ATC700B----MN--	MA62
ATC700B----RR--	MA63
ATC700B----FN--	MA63
ATC700B----RW--	MA64
ATC700B----RN--	MA64
ATC700B----AR--	MA65
ATC700B----NAIR--	MA66
ATC700B----AN--	MA66
ATC700B----AW--	MA67
ATC700B----BN--	MA67
ATC700B----P--	MA68

ATC P/N	MURATA P/N
<b>MA SERIES: X7R</b>	
ATC200A----W--	None, Solder Plated Terminations
ATC200A----C--	MA70
ATC200A----CN--	MA70
ATC200A----CA--	None, Gold Terminations
ATC200A----P--	MA78
ATC200B----W--	None, Solder Plated Terminations
ATC200B----WN--	None, Copper Barrier Solder Plated
ATC200B----PN--	None, Copper Barrier Solder Coated
ATC200B----C--	MA80
ATC200B----CA--	None, Gold Terminations
ATC200B----MS--	MA82
ATC200B----MN--	MA82
ATC200B----RR--	MA83
ATC200B----FN--	MA83
ATC200B----RW--	MA84
ATC200B----RN--	MA84
ATC200B----AR--	MA85
ATC200B----NAR--	MA86
ATC200B----AN--	MA86
ATC200B----AW--	MA87
ATC200B----BN--	MA87
ATC200B----P--	MA88

ATC P/N	MURATA P/N
<b>UFP SERIES: P90 ± 20 PPM/°C</b>	
ATC100E----W--	None, Chip
ATC100E----P--	None, Chip
ATC100E----CA--	None, Chip
ATC100E----C--	None, Chip
ATC100E----MS--	UFP12
ATC100E----AR--	UFP1
ATC100E----AW--	UFP17
ATC100E----RW--	None, Radial Leads

**Note:** Murata Capacitor body size is slightly larger than ATC's

Example:

ATC100A 101JC50 = MA 10 101J

## High Frequency Ceramic Capacitors

MA/MB Series

### SPECIFICATIONS

<b>Dissipation Factor</b>	MA/MB 1/2.; 0.05% maximum MA 5/6.; 0.15% maximum @ 1.0VRMS (f = 1 MHz) MA 7/8.; 2.5% maximum @ 1.0VRMS maximum (f = 1kHz)
<b>Temperature Coefficient</b>	MB2_ Series P90±30ppm/°C, (-55°C to +175°C) MA 1/2_ Series P90 ±20ppm/°C, (-55°C to +125°C) MA 5/6_ Series; C0G (0 ±30ppm/°C, -55°C to +125°C) MA 7/8_ Series; ±15% maximum (-55°C to +125°C)
<b>Insulation Resistance</b>	MA/MB 1/2_ 1T Ohms at +25°C, 100G Ohms at +125°C MA 5/6_ 1T Ohms at +25°C, 100G Ohms at +125°C MA 7/8_ 10G Ohms or 1000 Megohms μF min., whichever is less (@ 25°C) 10G Ohms or 100 Megohms μF min., whichever is less (@ 125°C)
<b>Dielectric Test Voltage</b>	MA/MB 1/2_/5_/6_/7_/8_, 250% of WVDC for 5 seconds
<b>Capacitance Drift</b>	Meets or Exceeds MIL-PRF-55681 (Does not apply for MA 7/8.)
<b>Aging</b>	Negligible for MA/MB 1/2_/5_/6_, MA 7/8_; 2.5% per decade maximum
<b>Environmental Tests</b>	MIL-STD-202
<b>Vibration</b>	Method 204, Condition B
<b>Moisture Resistance</b>	Method 106
<b>Solderability</b>	Method 208
<b>Resistance to Soldering Heat</b>	Method 210, Condition B
<b>Thermal Shock</b>	Method 107, Condition A
<b>Life</b>	Method 108, Condition F
<b>Marking</b>	Standard MA/MB product is unmarked

### TAPE AND REEL PACKAGING

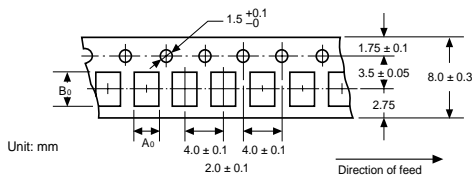

Unit: mm  
NOTE: 1 A<sub>0</sub> & B<sub>0</sub> are determined by maximum specified length and width of components plus 0.016 ± 0.008, plus the additional requirement that components not be allowed to rotate more than 20° within the cavity clearance or whichever condition occurs first.

### DIMENSIONS: mm

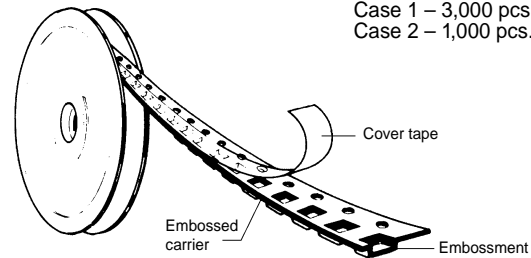

**PACKAGING:**  
Case 1 – 3,000 pcs.  
Case 2 – 1,000 pcs.\*

\*Custom quantities upon request.

### CONDUCTIVE TAPE

Advantages	Benefits
Conductive	Prevents static charge build-up
Flexibility	Insures against crazing, cracking and brittleness
Dimensional strength	Drive loading will not elongate sprocket holes
Dimensional stability	Smooth, reliable running on pick and place machines

Other packaging options available — Consult Factory

### ELECTRICAL PROPERTIES

Property	Value	Test Method
Resistivity	5 x 10 <sup>5</sup> ohm/square	ASTM D-257
Electrostatic Decay Time At 50% RH@21°C	0.01 Sec.	ASTM D-257

Typical Values

## High Frequency Ceramic Capacitors

HIGH Q, K, UY Series

2

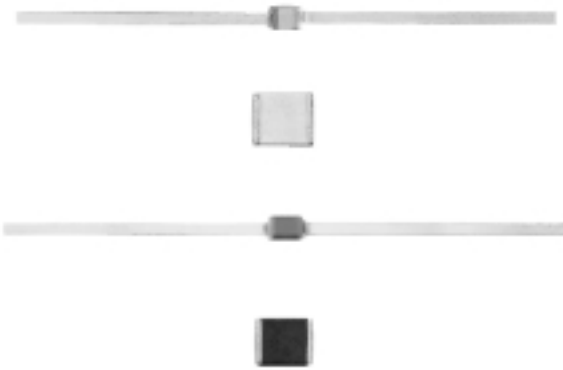

Precise ceramic dielectric layers are sintered into a solid monolithic structure. Silver leads are bonded to the capacitor by a unique solderless process. As a result, Uniceram High Q capacitors maintain stability despite extreme voltage and frequency variations, and severe environmental conditions. Their proprietary ceramic monolithic construction also yields high power handling capabilities per unit volume, as well as the ability to withstand temperatures well in excess of the melting point of solder.

Uniceram High Q capacitors can be provided with radial wire, axial ribbon or axial wire leads. They are also available as unencapsulated chips. These units are ideal for applications where low inductance is essential.

UY High K capacitors employ the same proprietary band metalization process as Murata High Q capacitors to insure peel-proof and leach-resistant termination. High K capacitors also use fine silver leads that are bonded to the capacitor using high temperature solder. Choose from Uniceram High K miniature chips or leaded capacitors with the assurance of performance that will live up to your expectations.

### CONFIGURATION & DIMENSIONS – UY Series

Style	Type		Configuration	Dimensions: mm						Termination
	P90 ± 20	X7R		P90 ± 20		X7R		Lead Spacing ± 0.78	Pantz "P"	
				L & W ± 0.78	T ± 0.78	L & W ± 0.78	T ± 1.01			
Axial Ribbon	UY01	—		2.77	1.57	—	—	—	1.19 max.	Silver Ribbon: Length: 22.23 min. Width: 1.27 ± .08 Thickness: 0.25 ± .08
	UY02	UY12		3.56	1.57	3.56	1.52			
	UY03	—		4.75	1.98	—	—			
	UY04	UY14		6.35	1.98	6.35	1.78			
	UY05	UY15		10.31	1.98	10.41	2.03			
Axial Wire	UY21	—		2.77	1.57	—	—	—	1.19 max.	Silver Wire (Diagonal of the rectangle forms the diameter of the wire): Length: 22.23 min. Width: .43 ± .025 Thickness: 0.41 ± .05
	UY22	UY32		3.56	1.57	3.56	1.52			
	UY23	—		4.75	1.98	—	—			
	UY24	UY34		6.35	1.98	6.35	1.78			
	UY25	UY35		10.31	1.98	10.41	2.03			
Radial Wire	UY62	UY72		3.56	1.57	3.56	1.52	3.12	1.19 max.	Silver Wire: Length: 22.23 min. Diameter: .58 ± .08
	UY63	—		4.75	1.98	—	—	4.45		
	UY64	UY74		6.35	1.98	6.35	1.78	5.72		
	UY65	UY75		10.31	1.98	2.8	2.03	9.53		
Type				L ± 0.38	W max.	T max.			Band Y	
Chips	WY01	—		2.77	2.92	1.52	0.38 Typ.	0.38 Typ.	Palladium Silver	
	WY02	—		3.53	3.56	1.52				
	WY03	—		4.72	4.70	3.56				
	WY04	—		6.10	6.10	2.03				
	WY05	—		10.67	10.67	2.29				

## High Frequency Ceramic Capacitors

HIGH Q, K, UY Series

### PART NUMBERING SYSTEM – High Q UY Series

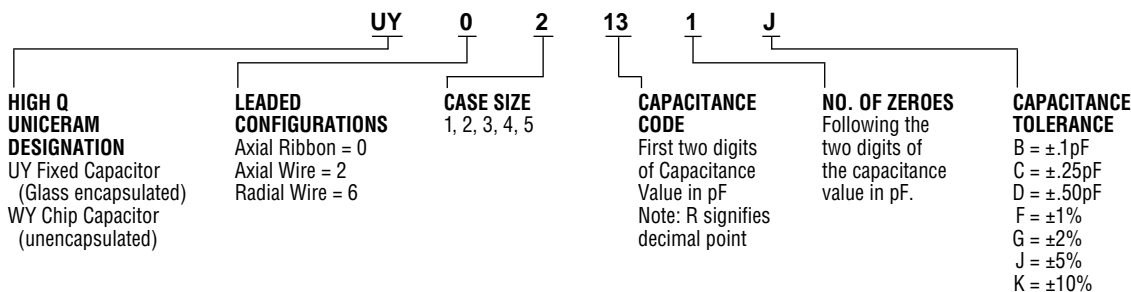

### SPECIFICATIONS

Operating Temp. Range	-55 to +125°C
Temp. Coefficient	+90 ± 20ppm/°C
Working Voltage	See Table
Dielectric Test Voltage	200% of rated working voltage
Capacitance Value	Measured at 1MHz and 1Vrms
Capacitance Tolerance	See Table
Quality Factor (Q)	for values 1000pF and smaller 2000 min. @ 1MHz
Dissipation Factor	for values above 1000pF .0002 max.
Insulation Resistance	@ 25°C: 10 <sup>6</sup> Megohms min., @ 125°C: 10 <sup>5</sup> Megohms min. or 500 ohm farads whichever is less
Marking	All capacitors are stamp marked with Co. I.D., Cap. Code and Tolerance, space permitting

### FEATURES

- High capacitance per unit volume
- Available in five sizes covering 0.5pF to 3000pF
- Other ceramic materials, metalizing bands, form factors and voltages available on special order
- Designed for direct connection to microwave substrates, headers, printed circuit boards and hybrid circuits

### PART NUMBERING SYSTEM – High K UY Series

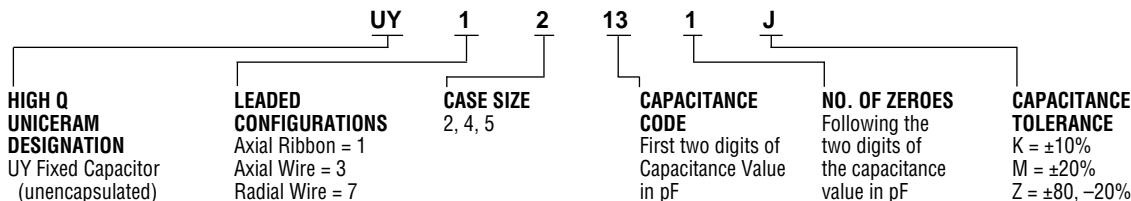

### SPECIFICATIONS

Dissipation Factor	2.5% max. @ 1kHz
Insulation Resistance	1000 megohm microfarad or 100G Ohms whichever is less @ 25°C
Temp. Coefficient	±15% max., -55°C to +125°C
Working Voltage	50 WVDC, Except as noted
Flash Test	2 x WVDC (5 sec. @ 25°C, 50ma. max.)
Life Test	2 x WVDC @ 125°C, 1000hrs.
Terminations	Palladium Silver: Band-width standard, .015 min.
Test Sequence	Capacitance, Dissipation Factor, Insulation Resistance, Flash Test
Marking	All capacitors are stamp marked with Co. I.D., Cap. Code and Tolerance, space permitting

### FEATURES

- High ratio of capacitance to unit volume for equivalent voltage, stability and current ratings

### CAPACITANCE RANGE

Case Size	Type	Part #	Capacitance Value						
			Min./Max.	50VDC	100VDC	200VDC	300VDC	500VDC	1000VDC
1	P90 ± 20	UY01, UY21, WY01	Min.	—	—	—	0.5pF	—	—
			Max.	—	—	—	100pF	—	—
2	P90 ± 20	UY02, UY22, UY62, WY02	Min.	—	—	—	5.1pF	—	—
			Max.	—	—	—	130pF	—	—
	X7R	UY12, UY32, UY72	Min.	110000pF	51000pF	—	—	2700pF	1000pF
			Max.	220000pF	100000pF	—	—	47000pF	2600pF
3	P90 ± 20	UY03, UY23, UY63, WY03	Min.	—	—	—	150pF	—	—
			Max.	—	—	—	470pF	—	—
4	P90 ± 20	UY04, UY24, UY64, WY04	Min.	—	—	—	510pF	—	—
			Max.	—	—	—	1000pF	—	—
	X7R	UY14, UY34, UY74	Min.	—	160000pF	130000pF	—	30000pF	8200pF
			Max.	—	1000000pF	150000pF	—	120000pF	27000pF
5	P90 ± 20	UY05, UY25, UY65, WY05	Min.	—	—	—	1100pF	—	—
			Max.	—	—	—	3000pF	—	—
	X7R	UY15, UY35, UY75	Min.	—	2000000pF	510000pF	—	82000pF	—
			Max.	—	2200000pF	1800000pF	—	470000pF	—

## RF Power Capacitors

UFP/UFN Series

UFP fixed ceramic capacitors are specifically designed for high voltage and high RF current high frequency applications. They are ideally suited to the latest aerospace and commercial mobile and fixed communications equipment.

Glass encapsulation protects UFP capacitors against corona, contaminants and other environmental factors. Wide, fine silver lead terminations assure minimum inductance and high RF current capabilities. They can withstand temperatures far in excess of soldered units due to solderless lead attachment.



3

### CONFIGURATION & DIMENSIONS – UFP/UFN Series

Style	Type		Configuration	Dimensions: mm				Leads	
	P90 ± 20	COG		L Max	W Max	T Max			Pantz "P"
						P90	NP0		
Axial Ribbon	UFP1	UFN15		14.73	13.89	4.37	5.33	1.9 Max	Silver Ribbon: Length: 19.05 Minimum Width: 8.89 Typical Thickness: 0.25 Typical
Raised Axial Ribbon	UFP12	UFN12		14.73	13.89	5.64	6.60	1.19 Max	Silver Ribbon: Length: 19.05 Minimum Width: 8.89 Typical Thickness: 0.25 Typical D = 0.76 ± 0.38
Axial Wire	UFP17	UFN17		14.73	13.89	4.37	5.33	1.19 Max	Silver Wire: Length: 15.24 Minimum Diameter: 0.81 Typical

Notes: For custom lead configuration, see page 15.

## RF Power Capacitors

UFP/UFN Series

### CAPACITANCE RANGE

Type	Part #	Capacitance Value						
		Min/Max	300VDC	600VDC	1200VDC	2500VDC	3600VDC	5000VDC
P90±20	UFP1, UFP12, UFP17	Min	1500pF	680pF	360pF	160pF	3pF	—
		Max	3000pF	1300pF	620pF	330pF	150pF	—
COG	UFN12, UFN15, UFN17	Min	—	—	—	—	—	1.5pF
		Max	—	—	—	—	—	360pF

### PART NUMBERING SYSTEM

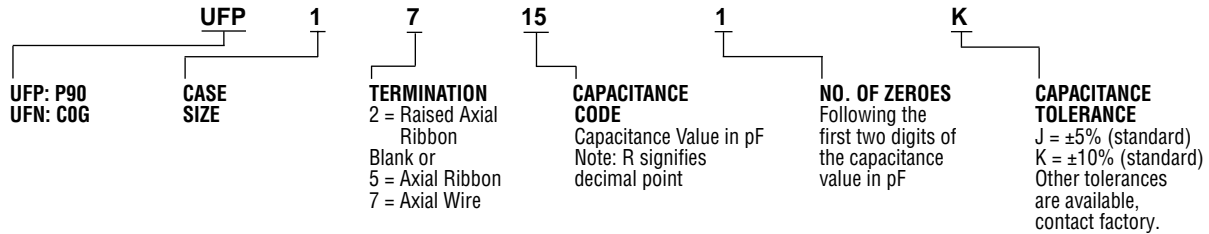

### SPECIFICATIONS

**Voltage:** See chart below

**Q:** 5,000 min. at 1MHz and 25°C for values 1,000pF and smaller

**Tolerances:** ±0.5pF for values below 10pF

±5%, ±10% for higher values

**Power:** 12 KVAR at 25°C typical

**Current:** 8 amperes at 25°C (Derated for higher temperatures)

**UFP Temperature Coefficient:** +90, ±20ppm/°C at 1 MHz  
(-55°C to +125°C)

**UFN Temperature Coefficient:** 0 ± 30ppm/°X at 1 MHz  
(-55°C to +125°C)

**Marking:** All capacitors stamp marked with company I.D., cap. code and tolerance

Type	Range of Cap. Values (pF)	Rated Voltage (DC)	DWV	RF Current ARMS at +25°C	RF Voltage VRMS at +25°C	RF Power KVAR at +25°C	Voltage Limiting Impedance (ohms)	Current Limiting Impedance (ohms)
UFP1	10 to 150	3,600	7,000	8	3,000	12	750	187.5
	160 to 330	2,500	4,500	8	2,000	12	333.3	187.5
	360 to 620	1,200	2,400	8	1,000	6	166.7	93.75
	680 to 1,300	600	1,200	8	500	3	83.3	46.88
	1,500 to 3,000	300	600	8	250	1.5	41.67	23.44
UFN1	1.5 to 360	5,000	8,000	8	4,000	12	1333	187.5

**Notes:** RF Current, Voltage and KVAR define Operating range using the Voltage Limiting and Current Limiting Impedances.

- When the Impedance of the capacitor is higher than the Voltage Limiting Impedance, the limiting factor is the RF Voltage.
- When the Impedance of the capacitor is less than the Current Limiting Impedance, the limiting factor is the RF current.
- When the Impedance of the capacitor is between these two values, the limiting factor is the RF Power.
- RF current rating derates 0.4%/°C from +25°C rating to +125°C.
- RF Power rating derates 0.5%/°C from +25°C rating to +125°C.
- RF Current rating derates 0.16%/°C from +25°C rating to +125°C.

Formulas for Voltage and Current when the capacitor is Power Limited are:

$$\text{RF Voltage} = (1,000 \times \text{KVAR} \times \text{IMPEDANCE})^{1/2} \quad I = \left( \frac{1,000 \times \text{KVAR}}{\text{IMPEDANCE}} \right)^{1/2}$$

$$\text{RF Current} = (1,000 \times \text{KVAR} \times \text{IMPEDANCE})^{1/2} \quad I = \left( \frac{1,000 \times \text{KVAR}}{\text{IMPEDANCE}} \right)^{1/2}$$

### EXAMPLES OF AVAILABLE LEAD CONFIGURATIONS

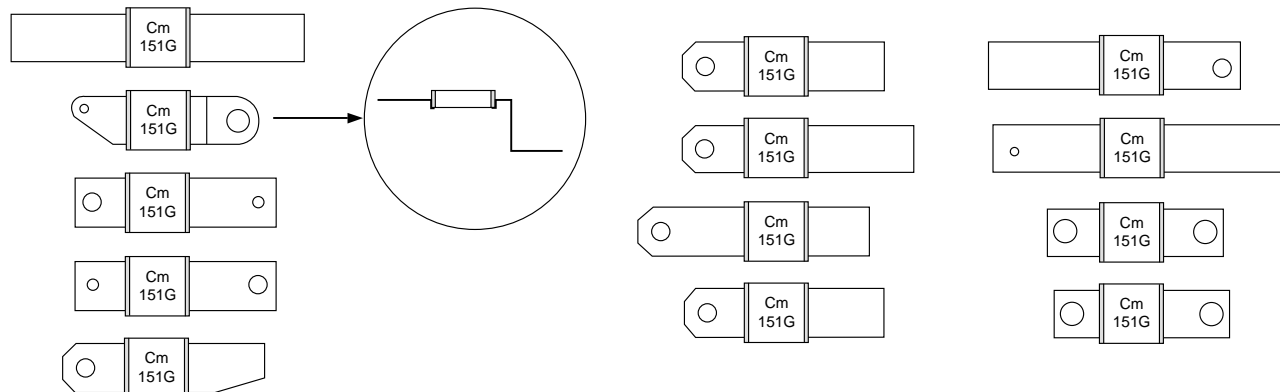

## RF Power Capacitors

### High Q UV Series

Uniceram high power and high voltage RF Capacitors provide options of chip style, or silver leads. They are suited for power communication equipment, requiring high RF voltage or current.

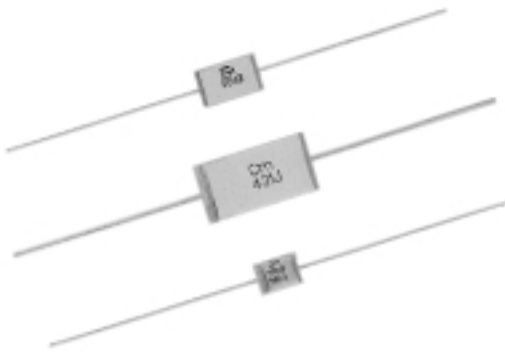

### CAPACITANCE RANGE

Case Size	Part #	2,500VDC
1	UV11, UV17	Min. 1.5pF, Max. 130pF
	UV41, UV47	Min. 3.3pF, Max. 160pF
2	UV21, UV27	Min. 150pF, Max. 330pF
	UV51, UV57	Contact factory
3	UV31, UV35, UV37	Min. 330pF, Max. 910pF
	UV61, UV65, UV67	Contact factory

4

### CONFIGURATION & DIMENSIONS – UV Series

Style	Type		Configuration	Dimensions: mm			Termination
	P90 ± 20	COG		L ± 0.76	W ± 0.76	T ± 0.76	
Pellet	UV11	UV41		7.62	5.59	3.30	Palladium Silver & Sn62 Solder
	UV21	UV51		12.45	6.86	3.43	
	UV31	UV61		21.84	11.18	3.43	
Axial Ribbon	UV35	UV65		21.84	11.18	3.68	Silver Ribbon: Length: 19.05 Minimum Width: 8.89 Typical Thickness: 0.25 Typical
Axial Wire	UV17	UV47		7.62	5.59	3.30	Tin Plated Copper Axial Wire: Length: 31.75 Minimum Diameter: .64 Typical
	UV27	UV57		12.45	6.86	3.43	Tin Plated Copper Axial Wire: Length: 31.75 Minimum Diameter: .64 Typical
	UV37	UV67		21.84	11.18	3.68	Tin Plated Copper Axial Wire: Length: 31.75 Minimum Diameter: .81 Typical

### PART NUMBERING SYSTEM

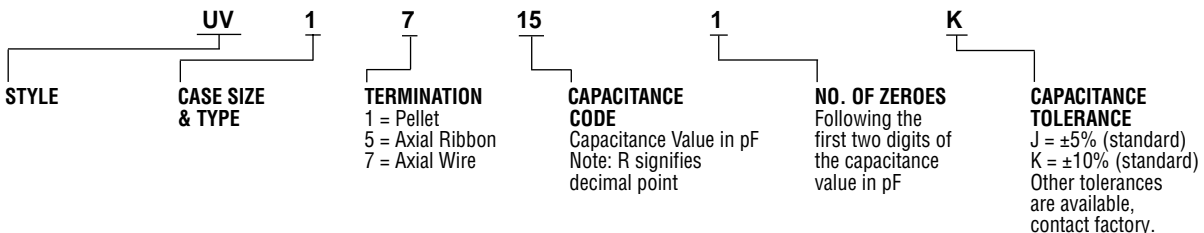

## Global Part Numbering System

RFE Series

### Monolithic Ceramic Capacitors Lead Type

(Global Part Number) 

RFE	3E	E	X7R	105	K	025	T1
-----	----	---	-----	-----	---	-----	----

  
① ② ③ ④ ⑤ ⑥ ⑦ ⑧

#### ① Type

Product ID	Series/Terminal	
RF	E	Radial leaded Hi-Reliability

#### ② Size Code

Code	Size	Old RPE Code
3E	3.5X3.1mm	RPE110
1B	7.75X7.62mm	RPE113
1C	1.27X1.27mm	Custom
1D	1.19X0.875mm	Custom
1E	11.45X10.95mm	Custom
1F	10.2X10.2mm	RPE114
1G	12.7X12.7mm, 10.2mm US	RPE117
1H	5.1X6.4mm, 2.5mm US	RPE121
1J	5.1X6.4mm, 5.1mm US	RPE122
1K	7.6X7.0mm, 5.1mm US	RPE123
1L	5.1X5.1mm, 2.5mm US	RPE131
1M	5.1X5.1mm, 5.1mm US	RPE132

#### ③ Thickness

Code	Size
E	2.5mm (.098° max)
S	2.8mm (.110° max)
F	3.2mm (.126° max)
G	3.8mm (.150° max)

#### ④ Temperature Characteristics

Code	Temp. Characteristics
C0G	0 ±30ppm (Note 1)
X7R	±15%
Z5U	+22, -56%
Y5V	+22, -82%
P2H	N150 ± 60ppm
R2H	N220 ± 60ppm
S2H	N330 ± 60ppm
T2H	N470 ± 60ppm
U2J	N750 ± 120ppm
U1G	N080
P2G	N150
R2G	N220

#### ⑤ Capacitance Code

Expressed in pico-farads (pF) and identified by a three-digit number. The first two digits represent significant figures. Last digit specifies the number of zeros to follow. For the fractional values below 10pF, the letter "R" is used as the decimal point and the last digit becomes significant.

#### ⑥ Capacitance Tolerance

C0G: 5pF or less

C = ±.25pF

>5pF ≤ 10pF

D = ±.5pF >10pF

J = ±5%

X7R: K = ±10%

Z5U: M = ±20%

Y5V: Z = +80, -20%

#### ⑦ Working VDC

Code	Working VDC
025	25VDC
050	50VDC
100	100VDC
200	200VDC
300	300VDC
500	500VDC
750	750VDC
1kV	1000VDC
XXX	Special, i.e. 1500, 125, etc.

#### ⑧ RFE Packaging/Leadform

Code	Packaging, Leadform
B1	Bulk, Straight lead
B2	Bulk, Inside kink lead
B3	Bulk, Outside kink lead
T1	Tray, Straight lead
T2	Tray, Inside kink lead
T3	Tray, Outside kink lead
U1	Anti-static Tray, straight lead
U2	Anti-static Tray, inside kink lead
U3	Anti-static Tray, outside kink lead
X1	Anti-static Tape cut into strips, straight lead
X2	Anti-static Tape cut into strips, inside kink lead
X3	Anti-static Tape cut into strips, outside kink lead
X4	Vertipack
Z	Special, not listed above

#### NOTE: T.C. Tolerance

Capacitance (pF)	T.C. Tolerance (ppm)
10 and over	± 30 (G)
4.0–9.9	± 60 (H)
2.1–3.9	±120 (J)
.4–2.0	±250 (K)

Refer to EIA RS-198 for limitations.

## High Reliability Capacitors

### RFE Series

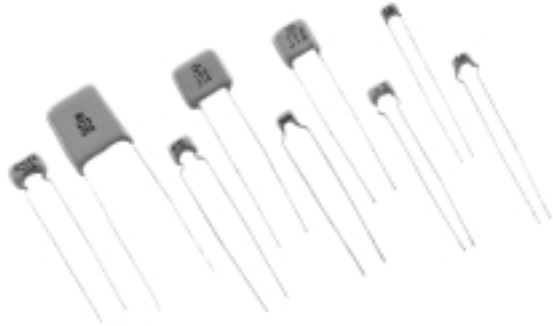

Murata offers High Reliability versions of most of the capacitors manufactured. Whether one wants screening of standard designs (100% Burn-In followed by Elevated Temperature Insulation Resistance, Room Temperature Insulation Resistance, Dielectric Withstanding Voltage, Capacitance, and Dissipation Factor Testing) or special high reliability designs with screening, Murata can supply your needs. Please consult the factory with your request. Murata Electronic's in-house Corporate QA Laboratory can mix and match testing to meet your requirements.

#### FEATURES

- Wide capacitance, T.C., voltage and tolerance range
- Industry standard sizes
- Various lead spacing available
- Marking standard or to customer specification
- Epoxy coating meets UL94V-0

5

### CONFIGURATION & DIMENSIONS – Hi-Rel RPE Series

Style	Configuration	Dimensions: mm				
		L max	W max	T max	Lead Diameter	Lead Spacing ± 0.76
RFE 1		3.5	3.1	2.5	AWG #26 0.4	2.5
RFE 3 Crimped Lead		5.1	6.4	3.2	AWG #24 0.5	2.5
RFE 3 Crimped Lead		5.1	6.4	3.2	AWG #24 0.5	5.1
RFE 2 Crimped Lead		5.1	5.1	3.2	AWG #25 0.45	2.5
RFE 2 Crimped Lead		5.1	5.1	3.2	AWG #25 0.45	5.1
RFE 4 Crimped Lead		7.6	7.0	3.2	AWG #24 0.5	5.1
RFE 5		7.6	7.6	4.0	AWG #24 0.5	5.1
RFE 6		10.2	10.2	4.0	AWG #24 0.5	5.1
RFE 7		12.7	12.7	5.1	AWG #24 0.5	10.2

## High Frequency, High Voltage Capacitors Global Part Numbering

ERB, 1kV, HkV Series

### Chip Monolithic Ceramic Capacitors

(Global Part Number) **ER** **B** **18** **8** **B1** **1H** **102** **K** **A01** **K**  
 ① ② ③ ④ ⑤ ⑥ ⑦ ⑧ ⑨ ⑩

#### ① Product ID

Product ID	Code	Series
GR	M	for Reflow, Flow/Reflow
	P	Soldering Electrode
ER	B	High-frequency Type (Ni/Sn Termination)
	F	High-frequency and high-power Type
	H	High-frequency and high-power Type (Ribbon Terminal)
	A	High-frequency Type
	D	High-frequency Type (Ribbon Terminal)
GQ	M	High-frequency for Flow/Reflow Soldering
GM	A	Monolithic Microchip
GN	M	Capacitor Array
LL	L	Low ESL Wide-width Type
	A	Low ESL Capacitor Array
GJ	6	Low Dissipation
	2	Smoothing Type
GA	2	for AC250V (r.m.s.)
	3	Safety Standard Recognized Type

#### ③ Dimension (L×W)

Code	Dimension (L×W)	EIA
03	0.6×0.3 mm	0201
05	0.5×0.5 mm	0202
08	0.8×0.8 mm	0303
11	1.25×1.0 mm	0504
15	1.0×0.5 mm	0402
18	1.6×0.8 mm	0603
1X	Depends on individual standards.	
21	2.0×1.25 mm	0805
22	2.8×2.8 mm	1111
31	3.2×1.6 mm	1206
32	3.2×2.5 mm	1210
3X	Depends on individual standards.	
42	4.5×2.0 mm	1808
43	4.5×3.2 mm	1812
52	5.7×2.8 mm	2211
55	5.7×5.0 mm	2220

#### ④ Dimension (T)

Code	Dimension (T)
3	0.3 mm
4	4-elements (Array Type)
5	0.5 mm
6	0.6 mm
7	0.7 mm
8	0.8 mm
9	0.85 mm

#### ② Series

A	1.0 mm
B	1.25 mm
C	1.6 mm
D	2.0 mm
E	2.5 mm
M	1.15 mm
N	1.35 mm
R	1.8 mm
Q	1.5 mm
X	Depends on individual standards.

With the array type GNM series, "Dimension(T)" indicates the number of elements.

#### ⑤ Temperature Characteristics

Code	Temperature Characteristics	Temperature Range	Cap. Change or Temp. Coeff.
1X	SL	20 to 85°C	+350 to -1000ppm/°C
2C	CH	-55 to 125°C	0±60ppm/°C
2P	PH	-25 to 85°C	-150±60ppm/°C
2R	RH	-25 to 85°C	-220±60ppm/°C
2S	SH	-25 to 85°C	-330±60ppm/°C
2T	TH	-25 to 85°C	-470±60ppm/°C
3C	CJ	-55 to 125°C	0±120ppm/°C
3P	PJ	-25 to 85°C	-150±120ppm/°C
3R	RJ	-25 to 85°C	-220±120ppm/°C
3S	SJ	-25 to 85°C	-330±120ppm/°C
3T	TJ	-25 to 85°C	-470±120ppm/°C
3U	UJ	-25 to 85°C	-750±120ppm/°C
4C	CK	-55 to 125°C	0±250ppm/°C
5C	C0G	-55 to 125°C	0±30ppm/°C
6C	C0H	-55 to 125°C	0±60ppm/°C
6P	P2H	-55 to 85°C	-150±60ppm/°C
6R	R2H	-55 to 85°C	-220±60ppm/°C
6T	T2H	-55 to 85°C	-470±60ppm/°C
7U	U2J	-55 to 85°C	-750±120ppm/°C
B1	B (1/2Ur)	-25 to 85°C	±10%
B3	B	-25 to 85°C	±10%
E4	Z5U	10 to 85°C	+22, -82%
F1	F (1/2Ur)	-25 to 85°C	+30, -80%
F5	Y5V	-30 to 85°C	+22, -82%
R1	R (1/2Ur)	-55 to 125°C	±15%
R3	R	-55 to 125°C	±15%
R6	X5R	-55 to 85°C	±15%
R7	X7R	-55 to 125°C	±15%

Continued on the following page. 

## High Frequency, High Voltage Capacitors Global Part Numbering

ERB, 1kV, HkV Series

(Global Part Number) **ER** **B** **18** **8** **B1** **1H** **102** **K** **A01** **K**  
 ① ② ③ ④ ⑤ ⑥ ⑦ ⑧ ⑨ ⑩

### ⑥ Rated Voltage

Code	Rated Voltage
0J	DC6.3V
1A	DC10V
1C	DC16V
1E	DC25V
1H	DC50V
2A	DC100V
2D	DC200V
2E	DC250V
YD	DC300V
YJ	HKV
2H	DC500V
2J	DC630V
3A	DC1kV
3D	DC2kV
3F	DC3.15kV
E2	AC250V
GB	X2; AC250V (Safety Standard Recognized Type GB)
GC	X1, Y2; AC250V (Safety Standard Recognized Type GC)

### ⑨ Individual Specification Code

Code	Individual Specification
A**/B**/C**/W**	Base Metal Inner Electrode
Other than above	Precious Metal Inner Electrode

\* indicates an alphabet or figure.

### ⑩ Packaging

Code	Packaging
L	ø178mm Plastic Taping
D	ø178mm Paper Taping
K	ø330mm Plastic Taping
J	ø330mm Paper Taping
B	Bulk
C	Bulk Case
T	Bulk Tray

6

### ⑦ Capacitance

Expressed by three figures. The unit is pico-farad(pF). The first and second figures are significant digits, and the third figure expresses the number of zeros which follow the two numbers. If there is a decimal point, it is expressed by the capital letter "R". In this case, all figures are significant digits.

Ex.)

Code	Capacitance
R50	0.5pF
1R0	1.0pF
100	10pF
103	10000pF

### ⑧ Capacitance Tolerance

Code	Capacitance Tolerance
B	±0.1pF
C	±0.25pF
D	±0.5pF
G	±2%
J	±5%
K	±10%
M	±20%
Z	+80%, -20%
R	Depends on individual standards.

\* E24 series is also available.

## High Frequency Ceramic Capacitors

ERB Series



The ERB Series was designed specifically as an alternative to “cubic” chip capacitors in high-volume applications where low cost is a primary design objective. This product is manufactured with the same “low loss” COG ceramic formulation and electrode material as are used in our MA Series. The rectangular shapes of this ERB Series allow for greater manufacturing automation resulting in lower cost. ERB capacitors bridge the gap between standard COG chips and the high performance MA Series, offering a low cost, high Q capacitor. Applications include cellular phone, GPS, and RF LAN.

### FEATURES

- Miniature sizes
- Stable COG temperature coefficient
- Very high Q at high frequencies
- High RF power handling capabilities

### SPECIFICATIONS

Operating Temperature Range	-55 to + 125°C
Temperature Coefficient	0 ± 30 ppm/°C
Working Voltage	See table below.
Dielectric Test Voltage (D.C.)	250% of rated working voltage (except 500 Volt rated @ 200%)
Capacitance Tolerance	B, C, D, G, J, K Available: Specials on request
Quality Factor (Q)/ESR	Consult Factory
Insulation Resistance	@ 25°C: 0.1 to 470 pF: 1 Tohm Min. over 470 pF: 100 Gohm Min. @ 125°C: 0.1 to 470 pF: 100 Gohm Min. over 470 pF: 10 Gohm Min.
Marking	Standard product is unmarked

### CAPACITANCE RANGE

Part Number	EIA Code	Capacitance Value					
		Min./Max.	50VDC	100VDC	200VDC	300VDC	500VDC
ERB18	0603	Min.	—	—	1pF*	—	—
		Max.	—	—	100pF	—	—
ERB21	0805	Min.	150pF	110pF	1pF*	—	—
		Max.	160pF	140pF	100pF	—	—
ERB32	1210	Min.	510pF	240pF	160pF	130pF	3.3pF
		Max.	1000pF	470pF	220pF	150pF	120pF

\*Note: For <1pf capacitance, please call factory.

## Design Engineering Kits

ERB Series



- Miniature sizes
- Very high Q at high frequencies
- High RF power capabilities
- Impervious to adverse environmental conditions
- Low dissipation factors
- Perfect retrace capability
- High temperature stability
- Low noise

### GPN KIT

New GPN

ERB18-KIT-X-----

ERB21-KIT-X-----

ERB32-KIT-X-----

### PREVIOUS KIT

Previous SPN

Kit-GRM706

Kit-GRM708

Kit-GRM710

See next page for kit contents.

## Design Kits (continued)

ERB Series

### New GPN ERB18-KIT-X-----

### Previous P/N KIT-GRM706

No.	Previous SPN	New GPN	Qty
1	GRM706C0G1R0B200	ERB1885C2D1R0BDX1B	10
2	GRM706C0G1R1B200	ERB1885C2D1R1BDX1B	10
3	GRM706C0G1R2B200	ERB1885C2D1R2BDX1B	10
4	GRM706C0G1R3B200	ERB1885C2D1R3BDX1B	10
5	GRM706C0G1R5B200	ERB1885C2D1R5BDX1B	10
6	GRM706C0G1R6B200	ERB1885C2D1R6BDX1B	10
7	GRM706C0G1R8B200	ERB1885C2D1R8BDX1B	10
8	GRM706C0G2R0B200	ERB1885C2D2R0BDX1B	10
9	GRM706C0G2R4B200	ERB1885C2D2R4BDX1B	10
10	GRM706C0G2R7B200	ERB1885C2D2R7BDX1B	10
11	GRM706C0G3R0C200	ERB1885C2D3R0CDX1B	10
12	GRM706C0G3R3C200	ERB1885C2D3R3CDX1B	10
13	GRM706C0G3R6C200	ERB1885C2D3R6CDX1B	10
14	GRM706C0G3R9C200	ERB1885C2D3R9CDX1B	10
15	GRM706C0G4R3C200	ERB1885C2D4R3CDX1B	10
16	GRM706C0G4R7C200	ERB1885C2D4R7CDX1B	10
17	GRM706C0G5R1C200	ERB1885C2D5R1CDX1B	10
18	GRM706C0G5R6C200	ERB1885C2D5R6CDX1B	10
19	GRM706C0G6R2C200	ERB1885C2D6R2CDX1B	10
20	GRM706C0G6R8C200	ERB1885C2D6R8CDX1B	10
21	GRM706C0G7R5C200	ERB1885C2D7R5CDX5B	10
22	GRM706C0G8R2C200	ERB1885C2D8R2CDX5B	10
23	GRM706C0G9R1C200	ERB1885C2D9R1CDX5B	10
24	GRM706C0G100J200	ERB1885C2D100JDX5B	10
25	GRM706C0G120J200	ERB1885C2D120JDX5B	10
26	GRM706C0G150J200	ERB1885C2D150JDX5B	10
27	GRM706C0G180J200	ERB1885C2D180JDX5B	10
28	GRM706C0G220J200	ERB1885C2D220JDX5B	10
29	GRM706C0G270J200	ERB1885C2D270JDX5B	10
30	GRM706C0G330J200	ERB1885C2D330JDX5B	10
31	GRM706C0G390J200	ERB1885C2D390JDX5B	10
32	GRM706C0G470J200	ERB1885C2D470JDX5B	10
33	GRM706C0G560J200	ERB1885C2D560JDX5B	10
34	GRM706C0G680J200	ERB1885C2D680JDX5B	10
35	GRM706C0G820J200	ERB1885C2D820JDX5B	10
36	GRM706C0G101J200	ERB1885C2D101JDX5B	10

### New GPN ERB21-KIT-X-----

### Previous P/N KIT-GRM708

No.	Previous SPN	New GPN	Qty
1	GRM708C0G1R2C200	ERB21B5C2D1R2CDX1B	10
2	GRM708C0G1R5C200	ERB21B5C2D1R5CDX1B	10
3	GRM708C0G1R8C200	ERB21B5C2D1R8CDX1B	10
4	GRM708C0G2R2C200	ERB21B5C2D2R2CDX1B	10
5	GRM708C0G2R7D200	ERB21B5C2D2R7DDX1B	10
6	GRM708C0G3R3D200	ERB21B5C2D3R3DDX1B	10
7	GRM708C0G3R9D200	ERB21B5C2D3R9DDX1B	10
8	GRM708C0G4R7D200	ERB21B5C2D4R7DDX1B	10
9	GRM708C0G5R6D200	ERB21B5C2D5R6DDX1B	10
10	GRM708C0G6R8D200	ERB21B5C2D6R8DDX1B	10
11	GRM708C0G8R2D200	ERB21B5C2D8R2DDX1B	10
12	GRM708C0G100K200	ERB21B5C2D101KDX1B	10
13	GRM708C0G120K200	ERB21B5C2D120KDX1B	10
14	GRM708C0G150K200	ERB21B5C2D150KDX1B	10
15	GRM708C0G180K200	ERB21B5C2D180KDX1B	10
16	GRM708C0G220K200	ERB21B5C2D220KDX1B	10
17	GRM708C0G270K200	ERB21B5C2D270KDX1B	10
18	GRM708C0G330K200	ERB21B5C2D330KDX1B	10
19	GRM708C0G390K200	ERB21B5C2D390KDX1B	10
20	GRM708C0G470K200	ERB21B5C2D470KDX1B	10
21	GRM708C0G560K200	ERB21B5C2D560KDX1B	10
22	GRM708C0G680K200	ERB21B5C2D680KDX1B	10
23	GRM708C0G820K200	ERB21B5C2D820KDX1B	10
24	GRM708C0G101K200	ERB21B5C2D101KDX1B	10

### New GPN ERB32-KIT-X-----

### Previous P/N KIT-GRM710

No.	Previous SPN	New GPN	Qty
1	GRM710C0G3R3D200	ERB32Q5C2D3R3DDX1B	10
2	GRM710C0G3R9D200	ERB32Q5C2D3R9DDX1B	10
3	GRM710C0G4R7D200	ERB32Q5C2D4R7DDX1B	10
4	GRM710C0G5R6D200	ERB32Q5C2D5R6DDX1B	10
5	GRM710C0G6R8D200	ERB32Q5C2D6R8DDX1B	10
6	GRM710C0G8R2D200	ERB32Q5C2D8R2DDX1B	10
7	GRM710C0G100K200	ERB32Q5C2D100KDX1B	10
8	GRM710C0G120K200	ERB32Q5C2D120KDX1B	10
9	GRM710C0G150K200	ERB32Q5C2D150KDX1B	10
10	GRM710C0G180K200	ERB32Q5C2D180KDX1B	10
11	GRM710C0G220K200	ERB32Q5C2D220KDX1B	10
12	GRM710C0G270K200	ERB32Q5C2D270KDX1B	10
13	GRM710C0G330K200	ERB32Q5C2D330KDX1B	10
14	GRM710C0G390K200	ERB32Q5C2D390KDX1B	10
15	GRM710C0G470K200	ERB32Q5C2D470KDX1B	10
16	GRM710C0G560K200	ERB32Q5C2D560KDX1B	10
17	GRM710C0G680K200	ERB32Q5C2D680KDX1B	10
18	GRM710C0G820K200	ERB32Q5C2D820KDX1B	10
19	GRM710C0G101K200	ERB32Q5C2D101KDX1B	10

# Application Specific Capacitors

## High Frequency Ceramic Capacitors

ERB Series

### ENVIRONMENTAL

Aging	Negligible
Environmental Tests	MIL-STD-202
Moisture Resistance	Method 106
Solderability	Method 208
Resistance to Soldering Heat	Method 210, Condition B
Thermal Shock	Method 107, Condition A
Life	Method 108, Condition F

### STANDARD PACKAGING – TAPE & REEL

	QUANTITY PER 7" REEL	QUANTITY PER 13" REEL
ERB18	4000	10000
ERB21	3000	10000
ERB32	2000	8000

For sample kit contact factory.

### CONFIGURATION & DIMENSIONS – GR700 Series

Style	Type	EIA Style	Configuration	Dimensions: mm					Termination
	NPO			L	W	T Max	g min	Band Y min	
ERB18	COG	0603		1.6 ± .1	0.8 ± .1	0.9	0.5	0.2	Palladium Silver, Nickel Interface & Tin Plating
ERB21		0805		2.0 ± 0.3	1.25 ± 0.3	1.25	0.7	0.25	Palladium Silver, Nickel Interface & Tin Plating
ERB32		1210		3.2 ± 0.3	2.5 ± 0.3	1.52	1.0	0.3	Palladium Silver, Nickel Interface & Tin Plating

7

### TYPICAL HIGH FREQUENCY PERFORMANCE CHARTS

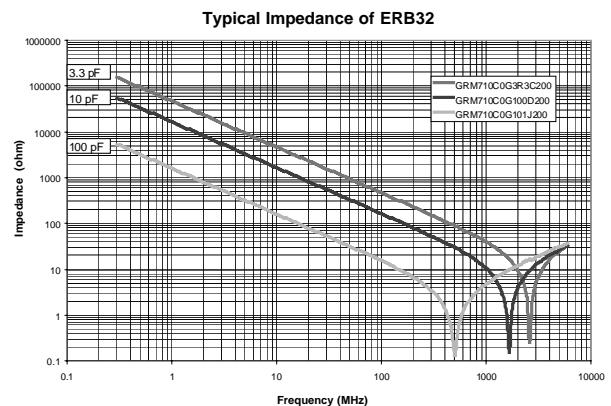
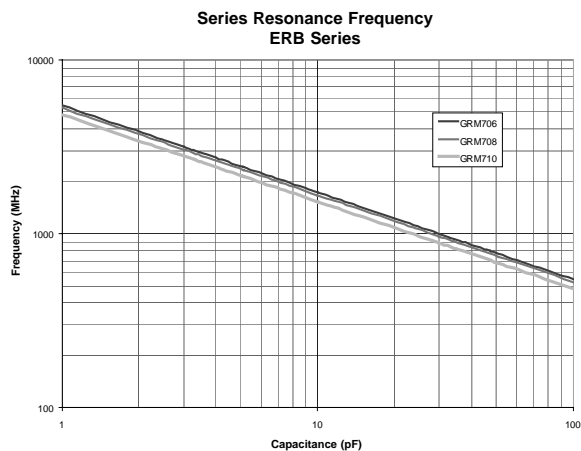

## High Frequency Ceramic Capacitors

ERB Series

Typical ESR Curve of ERB32

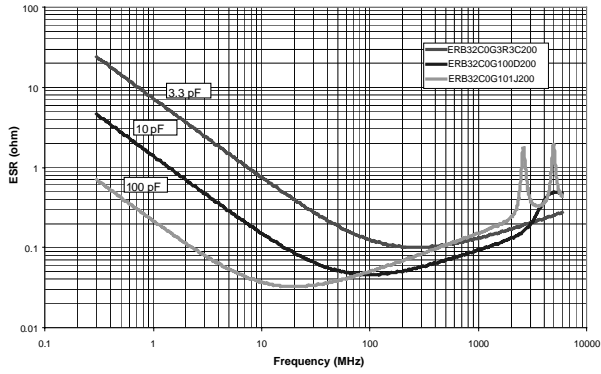

Typical Q of ERB32

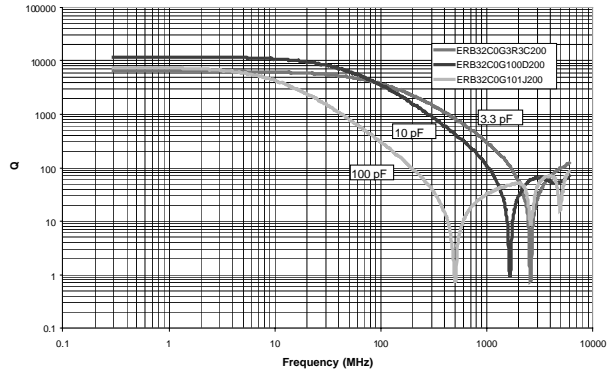

Typical Impedance of ERB31

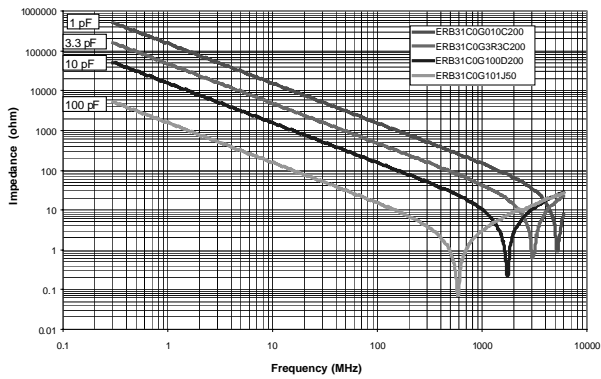

Typical Impedance of ERB18

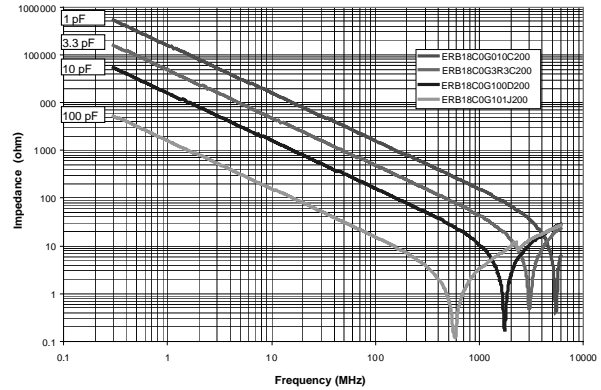

Typical ESR of ERB21

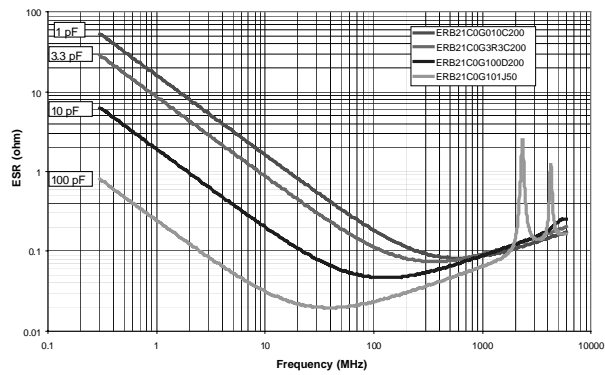

Typical ESR of ERB18

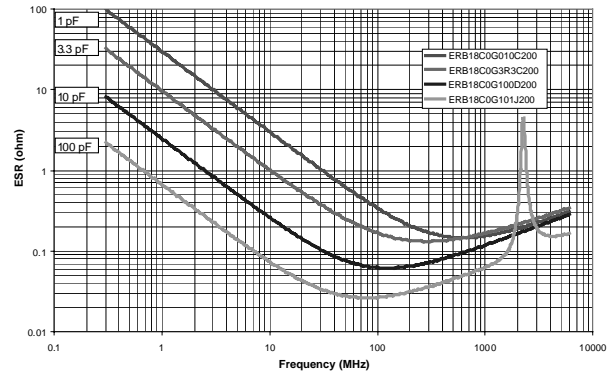

Typical Q of ERB21

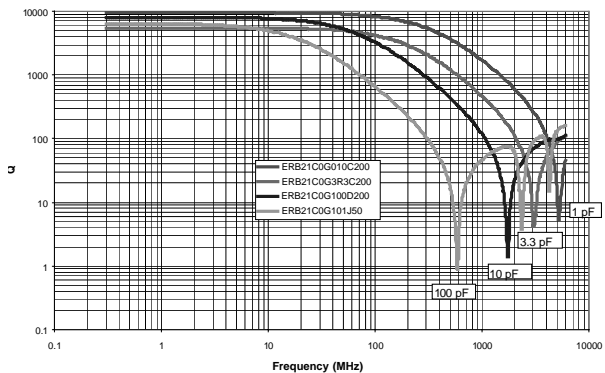

Typical Q of ERB18

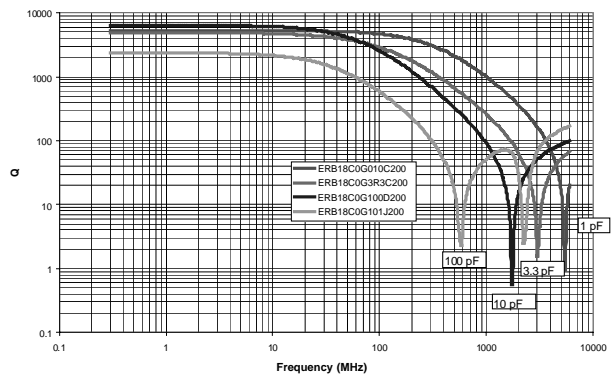

7

All information contained in  
this catalog is available in  
PDF downloadable format at  
[www.murata.com](http://www.murata.com).



*Innovator in Electronics*

Marketing Communications  
2200 Lake Park Drive  
Smyrna, Georgia 30080  
Tel: 770-436-1300  
Fax: 770-436-3030  
[www.murata.com](http://www.murata.com)

## “Preliminary Specification”

# HPP – High Performance Power Capacitor!

Designed Especially for  
High RF Power.

### Applications:

Semiconductor Plasma Chamber and  
other Thin Film Process Equipment.  
High Power RF/HF Amplifiers,  
Transmitters and Antenna Tuning.  
Medical Scanning (MRI Coils)  
High Power RF/HF Filters

This new ceramic capacitor series from MuRata Electronics has been developed for use in High Power RF applications where low dielectric loss and low ESR are essential to the performance of the equipment. The product is available in leaded form for assembly in coil assemblies or can be made in chip form for mounting in special configurations. The product is available with two lead attachment options – High Temperature Solder (<150°C operation) or Brazed Leads (>150°C operation). The HPP product can be made available with non-magnetic terminations for MRI applications. The newly developed HPP series is available in a wide range of cap values and voltages. It is capable of 12 kVAR reactive power in open mounting applications. Heat Sinking allows more power to be dissipated so that higher currents and power can be applied. The Dielectric features ultra low loss (High Q) and the ESR is tightly controlled by the process and capacitor design improvements. Special configurations and capacitance for specific application are available. For specific information, please consult the factory.

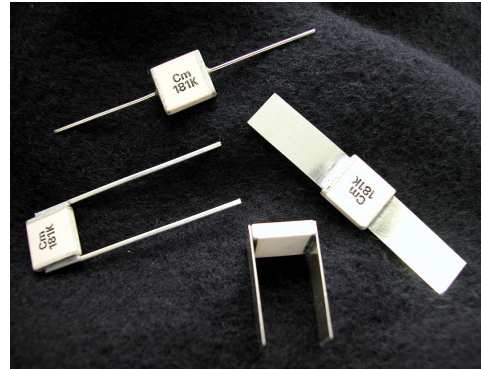

### PRODUCT FEATURES

**Dielectric:** P90 or C0G (NP0)

**Q** is greater than 10,000 at 1MHz (25°C)

**Voltage** Ratings from 300 to 7200Vdc

**Capacitance**

Values up to 1200 pF at **2500Vdc**

Values up to 680 pF at **3600Vdc**

Values up to 360 pF at **5000Vdc**

### Options

High Reliability Screening

Special Assemblies and Leads

Specific Application Designs

### Part Description:

#### Electrical Specifications:

**Q:** 10,000 minimum At 1 MHz, 25°C

**TCC:** P90: 90 ± 30 ppm / °C

C0G: 0 ± 30 ppm / °C

(-55 °C to 125 °C)

**Power:** 12kVAR at 25 °C typical

**Current:** 10 Arms typical

#### Chip Dimensions:

**Length:** 0.465 in (11.8 mm) nominal

**Width:** 0.420 in (10.7 mm) nominal

**Thickness:** 0.135 in (3.5 mm)

# HIGH PERFORMANCE POWER (HPP) CAPACITORS

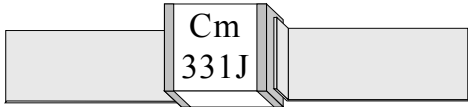
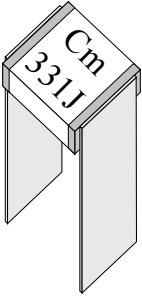
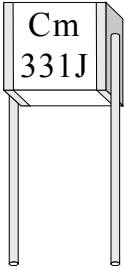
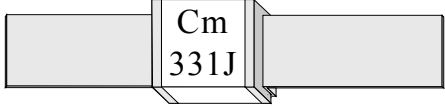
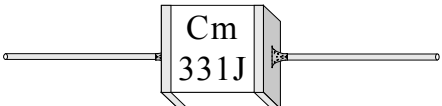
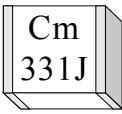
LEAD STYLE (Termination Code)	ILLUSTRATION	LEAD ATTACHMENT		Notes Dimensions in inches (mm)  Typ = Typical
		BRAZED	SOLDERED	
Axial Standoff (2)		HPP112	HPP132	Silver Ribbon: Length: 0.75 (19.0) min. Width: 0.35 (8.9) Typ Thick: 0.01 (0.25) Typ Sandoff: 0.03 (0.75) Typ
Radial Ribbon (3)		HPP113	HPP133	Silver Ribbon: Length: 0.75 (19.0) min. Width: 0.35 (8.9) Typ Thick: 0.01 (0.25) Typ
Radial Wire (4)		HPP114	HPP134	Silver Wire: Length: 0.60 (15.2) Min Diameter: 0.04 (1.0) Typ
Axial Ribbon (5)		HPP115	HPP135	Silver Ribbon: Length: 0.75 (19.0) min. Width: 0.35 (8.9) Typ Thick: 0.01 (0.25) Typ
Axial Wire (7)		HPP117	HPP137	Silver Wire: Length: 0.600 (15.24) Min Diameter: 0.032 (.81) Typ
Termination Code	ILLUSTRATION	Termination		
Chip (0) (Under Development)		HPP100: Pd/Ag, Cu Barrier, Sn Plating HPP101: Pd/Ag, Cu Barrier, Sn62 Solder Coating HPP108: Pd/Ag, Ni Barrier, Sn62 Solder Coating HPP109: Pd/Ag, Ni Barrier, Sn Plating		

**HPP1 P90 331J 3600V  
330 pF**

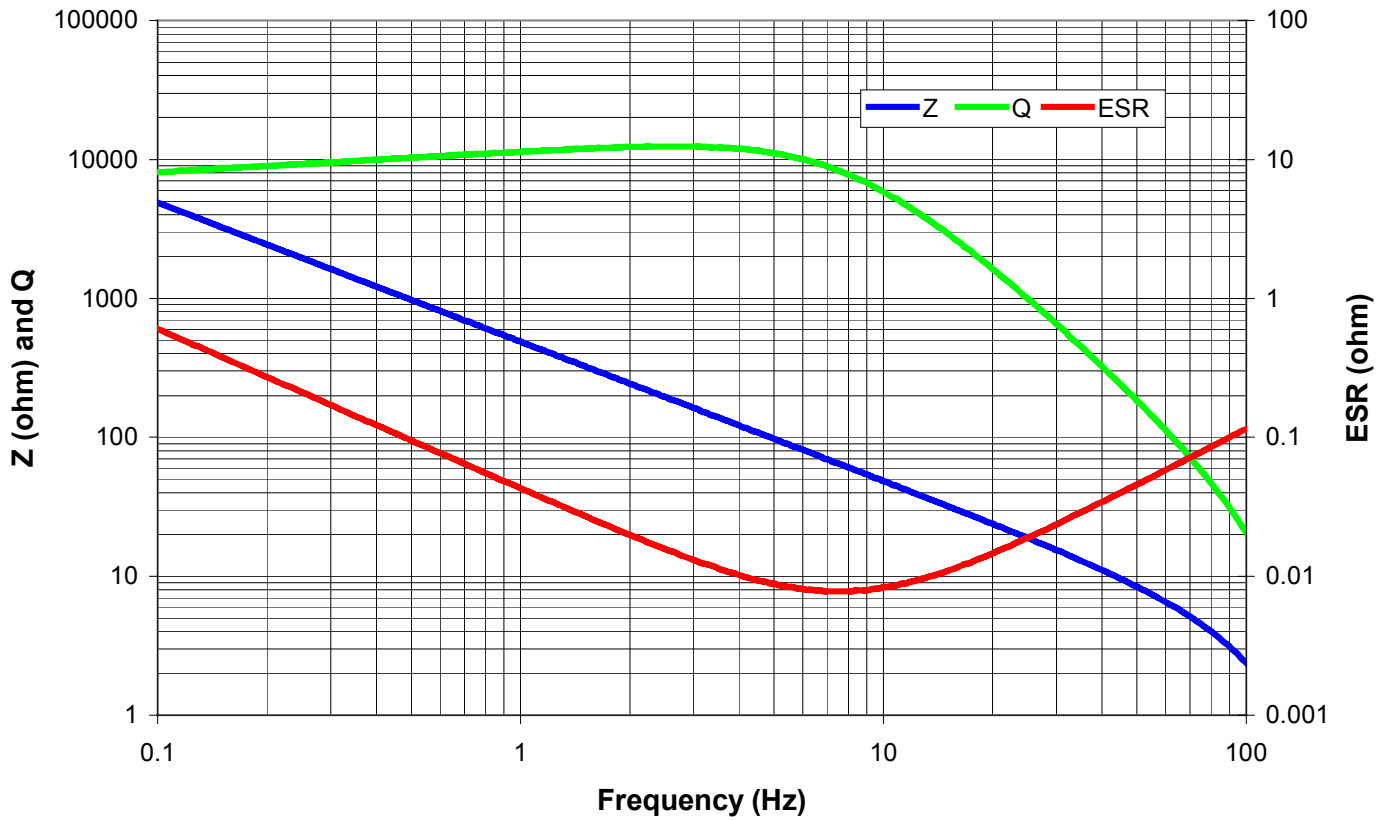

**Power Handling at 2 MHz  
HPP113P331J3600 vs ATC 100E331JAR3600**

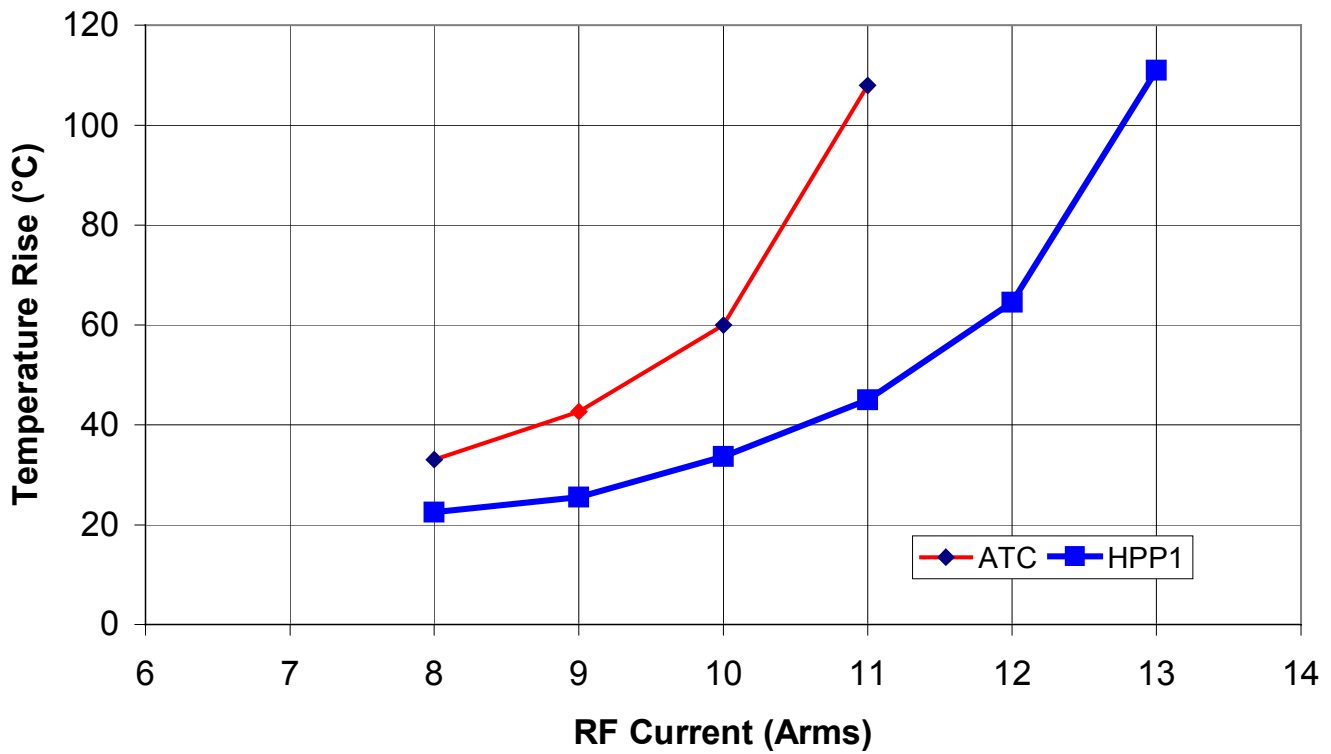

# Part Numbering System:

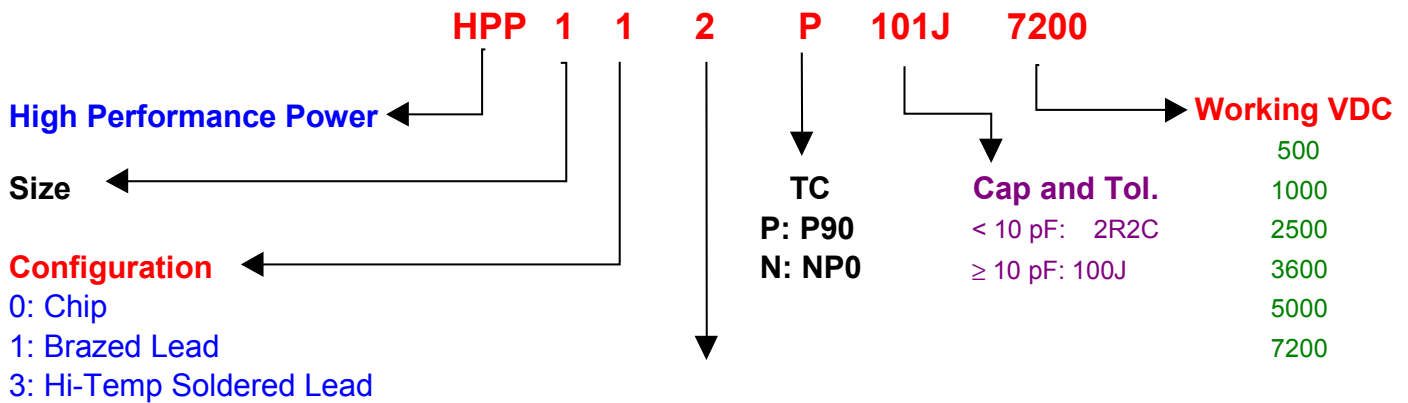

### Terminations

Chip	Leaded
0: Pd/Ag, Cu barrier, Sn Plating (Chip)	2: Silver Axial standoff Ribbon
1: Pd/Ag, Cu barrier, Sn 62 Solder coating (Chip)	3: Silver Radial Ribbon
8: Pd/Ag, Ni barrier, SN 62 Solder (Chip)	4: Silver Radial Wire
9: Pd/Ag, Ni barrier, Sn Plating (Chip)	5: Silver Axial Ribbon
	6: Not used
	7: Silver Axial Wire

## Environmental Tests:

Murata HPP capacitors are designed and manufactured to pass the following tests.

**Thermal Shock:** Mil Std 202, Method 107, condition A

**Moisture Resistance:** Mil Std 202, Method 106

**Low Voltage Humidity:** Mil Std 202, Method 103, Condition A, with 1.5 Volts D.C. applied while subjected to an environment at 85°C with 85% relative humidity for 240 hours minimum.

**Life Test:** Mil Std 202, Method 108 for 2000 hours at 125°C. With 1.2 times rated working voltage VDC.

## Contacts:

### Application Specific Capacitors

Karun Malhotra, Marketing Manager – Ext. 4834  
 Jim Canner, Senior Applications Engineer – Ext. 2032  
 Shoji Tsubota, Product Manager – [stsubota@murata.com](mailto:stsubota@murata.com)

Murata Electronics  
 1900 West College Ave.  
 State College, PA 16801-2799  
 (814)-237-1431

[www.murata.com](http://www.murata.com)