



LCMXO3LF-9400C-ASC-B-EVN
LATTICE SEMICONDUCTOR

[Buy Now](#)



Looking for a discount?

[Check out our current promotions!](#)

Give us a call

1-855-837-4225

International: 1-415-281-3866

Email Us

Sales and New Orders: sales@verical.com

Order Support: support@verical.com

Suppliers: [Visit our seller page](#)

Company Address

Arrow Electronics, Inc
9201 East Dry Creek Road
Centennial, CO 80112



PRODUCT SELECTOR GUIDE

DECEMBER 2021

SOLUTIONS • FPGAs • IP • REFERENCE DESIGNS • DEVELOPMENT KITS • DESIGN TOOLS

The Lattice Advantage



CONTENTS

- Solution Stacks4-11
- FPGA Products12-13
- Video Connectivity14-15
- Ultra Low Power.....16
- Control & Security17-18
- Power and Thermal Management Products.....19
- IP Cores and Reference Designs.....20-24
- Development Kits25-34
- Programming Hardware.....35
- Design Software36-37

Lattice sensAI™ Solution Stack

Accelerate Integration of Flexible, Ultra Low Power Inferencing

With solutions optimized for ultra low power consumption (under 1 mW – 1 W), small package size (5.5 mm²– 100 mm²), customizable performance and accuracy, and interface flexibility (MIPI CSI-2, LVDS, GigE, etc.), the Lattice sensAI stack accelerates integration of scalable, always-on, on-device AI.

Lattice mVision™ Solution Stack

Accelerate Implementation of Low Power Embedded Vision Applications

With solutions optimized for low power consumption ranging from under 150 mW to 1 W and small package size (2.5 x 2.5 mm to 10 x 10 mm) the Lattice mVision solution stack provides customizable performance and flexible interface connectivity (MIPI CSI-2, LVDS, PCIe, GigE, etc.). Lattice's mVision solution stack accelerates the integration of scalable Embedded Vision solutions for Smart Factory, Machine Vision, Smart City, and Smart Home applications.

Lattice Sentry™ Solution Stack

Software Solution for Platform Firmware Resiliency (PFR) Root of Trust

The Lattice Sentry solution stack consists of a complete reference platform, fully validated IP building blocks, easy to use FPGA design tools, reference design/demonstrations, as well as a network of custom design services. In many instances, a fully functioning PFR solution can be developed by modifying the included RISC-V C source code.

Lattice Automate™ Solution Stack

Lattice Automate helps designers accelerate high performance, low power, secure solutions for next generation factory automation solutions. The stack includes modular hardware development boards and software-programmable reference designs and demos that simplify and accelerate implementation of applications like robotics, scalable multi-channel motor control with predictive maintenance, and real-time industrial networking.

Lattice SupplyGuard™

End-to-End Supply Chain Protection Service

The Lattice SupplyGuard™ service provides customers with factory-locked ICs. These ICs can only be programmed using a configuration bitstream which has been developed, signed and encrypted by the intended customer. The solution is designed to provide protection against counterfeiting, over-building, malware insertion and IP theft.

General Purpose FPGAs

Low Power FPGAs (CertusPro-NX, Certus-NX, ECP, and LatticeXP2 families)

Addresses a broad range of connectivity and acceleration applications across multiple markets.

- Lowest power and smallest package with up to 10G SERDES and 100K LCs
- Industry-leading reliability and efficient processing (with class-leading on-chip memory and LPDDR4 support)

Specialized Families Tailored For Specific Needs

Video Connectivity FPGAs (CrossLink Families)

Optimized for high speed video and sensor applications

- First FPGA with hardened MIPI D-PHY
- Highest performance at lowest power

Ultra Low Power FPGAs (iCE40 Families)

World's lowest power FPGAs; Optimized for small form factor

- Static current as low as 25 uA
- World's most popular ultra low power FPGA

Control & Security FPGAs (Mach & L-ASC10 Families)

Optimized for platform management & security applications

- Instant-on, non-volatile
- Highest I/O density

Ultra Low Power Lattice sensAI™ Stack

Delivering Milliwatt AI to the Edge with Flexible FPGAs

With solutions optimized for ultra low power consumption (under 1 mW – 1 W), small package size (5.5 mm²– 100 mm²), customizable performance and accuracy, and interface flexibility (MIPI CSI-2, LVDS, GigE, etc.), the Lattice sensAI stack accelerates integration of scalable, always-on, on-device AI.

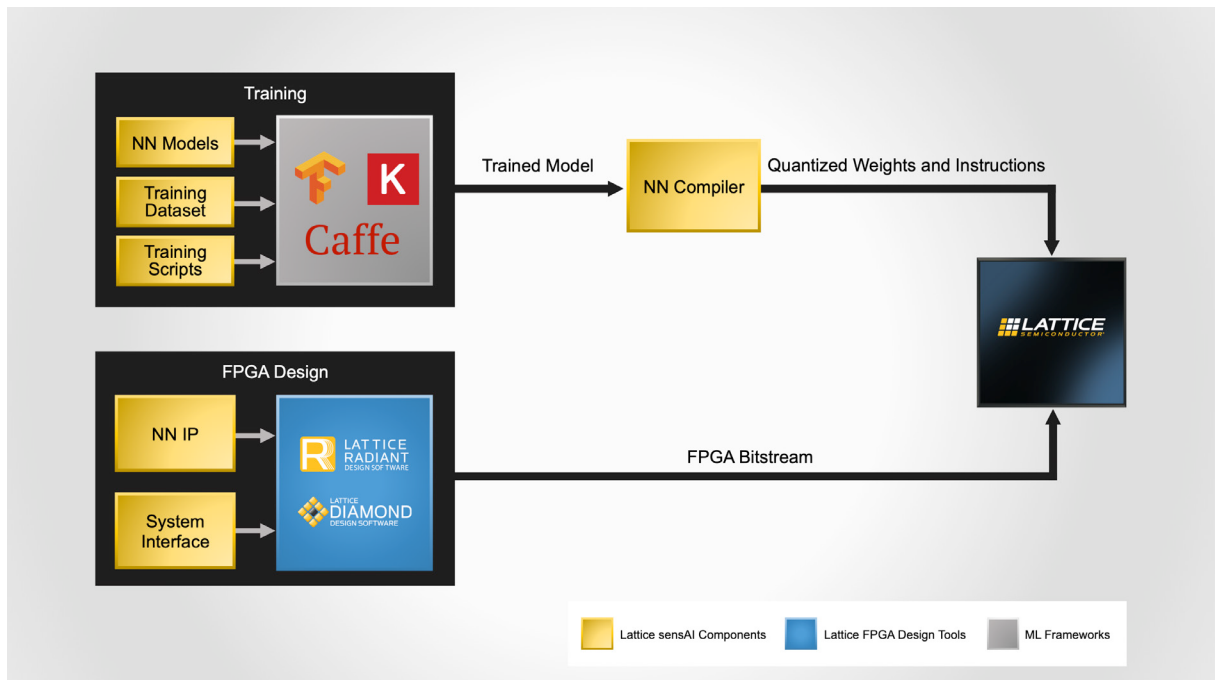
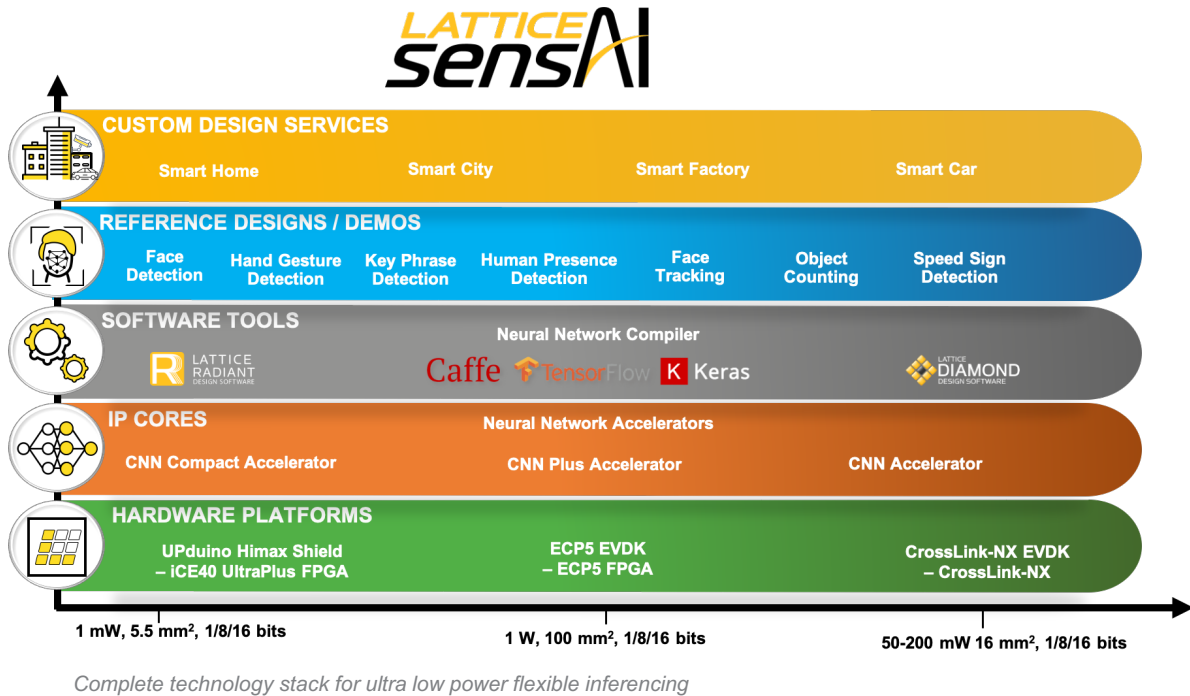

Rapid design space exploration - Performance vs Power vs Accuracy tradeoffs

Solution Stack – Lattice sensAI

Lattice sensAI Hardware Platforms



- **CrossLink-NX VIP Sensor Input Board**
 - Key Features:
 - Seamless connectivity to the Embedded Vision Development Kit
 - Optimized for fast prototyping vision-based AI acceleration



- **Embedded Vision Development Kit**
 - Key Features:
 - ECP5™ FPGA consuming under 1 W of power consumption
 - Supports MIPI CSI-2, eDP, HDMI®, GigE Vision, USB 3.0, etc.

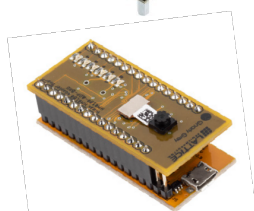

- **HM01B0 UPduino Shield**
 - Key Features:
 - A complete development kit for implementing AI using vision and sound as sensory inputs
 - iCE40 UltraPlus FPGA based Upduino 2.0 board and HiMax image sensor module

Lattice sensAI IP Cores

IP Core	OPN	Key Features
CNN Compact Accelerator	CNN-CPACCEL-UP-U	Optimized for iCE40 UltraPlus FPGA, supports variable quantization
CNN Accelerator	CNN-ACCEL-E5-U	Optimized for ECP5 FPGA, supports variable quantization
CNN Plus Accelerator	CNNPLUS-ACCEL-CNX-U	For use with CrossLink-NX FPGA, supports compact and high performance modes

Lattice sensAI Software Tools

Software Tool	Key Features
Neural Network Compiler	Supports TensorFlow, Keras and Caffe. No prior RTL experience required.

Lattice sensAI Reference Designs

Reference Design/Demo	Supported FPGA, HW Platform	Power Consumption
Human Face Identification	ECP5, Embedded Vision Development Kit	< 1 W
Object Counting	ECP5, Embedded Vision Development Kit	< 1 W
Object Counting	CrossLink-NX, CrossLink-NX VIP Sensor Input Board	200 mW
Human Presence Detection	iCE40 UltraPlus/HiMax HM01B0 UPduino Shield	< 8 mW
Key Phrase Detection	iCE40 UltraPlus, iCE40 UltraPlus Mobile Development Platform	< 8 mW

Lattice sensAI Stack Custom Design Services

Have custom AI solution needs? The senseAI stack includes an ecosystem of select, global design service partners that can deliver custom solutions for a range of end applications, including Smart Home, Smart City, Smart Factory, and Smart Cars. Please contact your local sales representative to request more information.

For more information go to LATTICESEMI.COM/SENSAI

Lattice mVision™ Solution Stack

Accelerate Implementation of Low Power Embedded Vision Applications

With solutions optimized for low power consumption ranging from under 150 mW to 1 W and small package size (2.5 x 2.5 mm to 10 x 10 mm) Lattice mVision solution stack provides customizable performance and flexible interface connectivity (MIPI CSI-2, LVDS, PCIe, GigE, etc.). Lattice's mVision solution stack accelerates the integration of scalable Embedded Vision solutions for Smart Factory, Machine Vision, Smart City, and Smart Home applications.

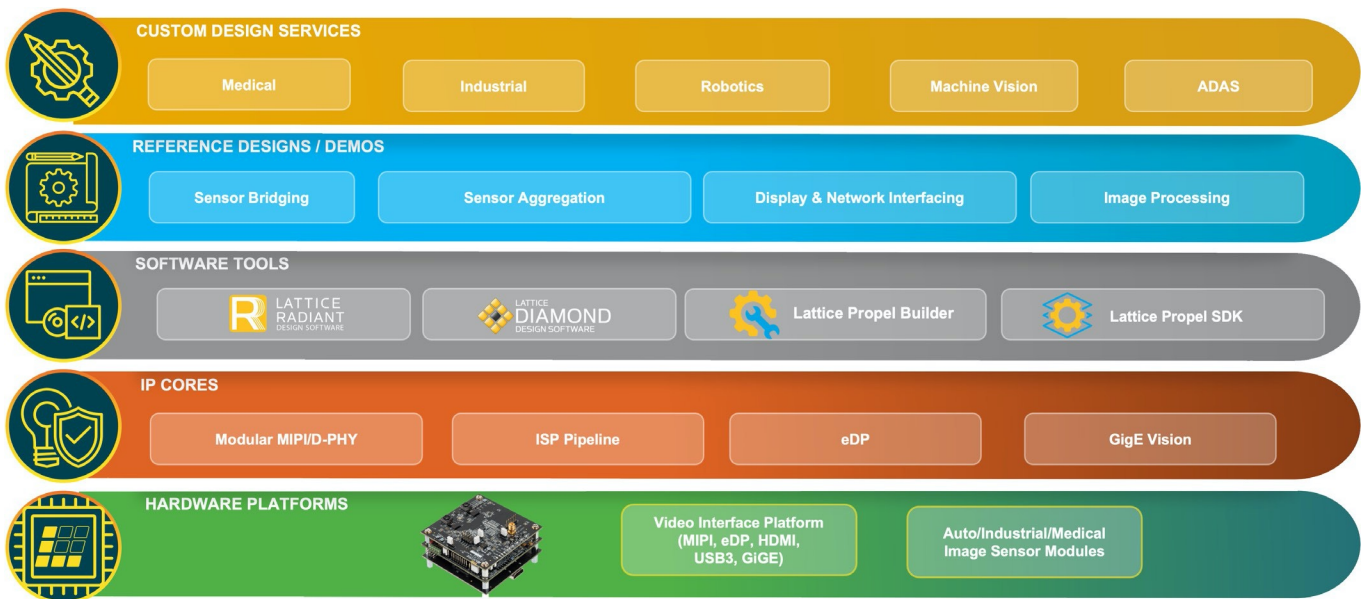

Lattice mVision Hardware Platforms

The Lattice mVision solution stack uses the award-winning Video Interface Platform (VIP) (www.latticesemi.com/vip) which is the ideal hardware for Embedded Vision designs and it provides a highly flexible, smart modular solution for Embedded Vision designers who need to build a prototyping system quickly.

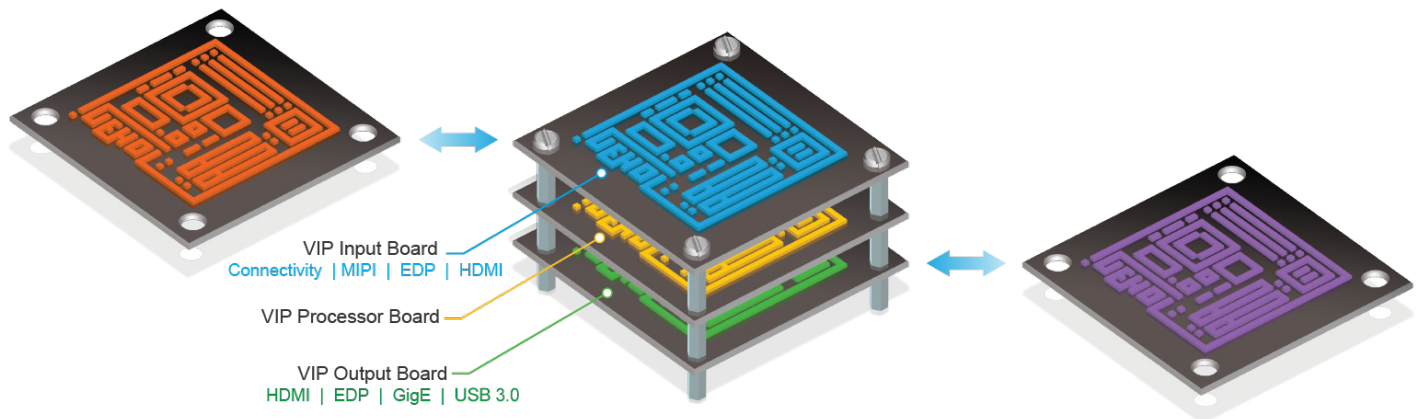

Solution Stack – Lattice mVision

Lattice mVision IP Cores

CSI-2/DSI D-PHY Receiver	FPD-LINK Receiver
CSI-2/DSI D-PHY Transmitter	FPD-LINK Transmitter
Byte to Pixel Converter	Color Space Converter
Pixel to Byte Converter	Video Frame Buffer
SubLVDS Image Sensor Receiver	Gamma Corrector
	2D Scaler

Lattice mVision Partner IP

Helion IONOS Image Signal Processing (ISP)
Bitec DisplayPort IP
Helion GigE Vision IP

Lattice mVision Design Tools

Lattice's mVision solution stack uses Lattice's standard Radiant and Diamond FPGA design tools for ease of use and fast system design.



Lattice mVision Reference Designs

N Input to 1 Output MIPI CSI-2 Camera Aggregator Bridge
4 to 1 Image Aggregation with CrossLink-NX
SubLVDS to MIPI CSI-2 Image Sensor Bridge 4 to 1 Image
MIPI DSI/CSI-2 to OpenLDI LVDS Interface Bridge

Lattice mVision Demonstrations

4 to 1 Image Aggregation Demo for CrossLink-NX Image Input Board	DisplayPort Transmit Demo
2 to 1 side by side Demo for CrossLink on EVDK	Helion GigE Vision
3D Depth-Mapping	IONOS ISP from Helion
Video over USB 3.0	DisplayPort Receive Demo
Video over Ethernet	

Lattice mVision Custom Design Services

Have custom Embedded Vision solutions needs? The Lattice mVision stack includes an ecosystem of select, global design service partners that can deliver custom solutions for a range of end applications, including Factory, Smart Home, Smart City, and Smart Cars. Please contact your local sales representative to request more information.

For more information go to LATTICESEMI.COM/MVISION

Lattice Sentry™ Solution Stack

Dynamic PFR Solution for Comprehensive Coverage of NIST 800-193 Guidelines

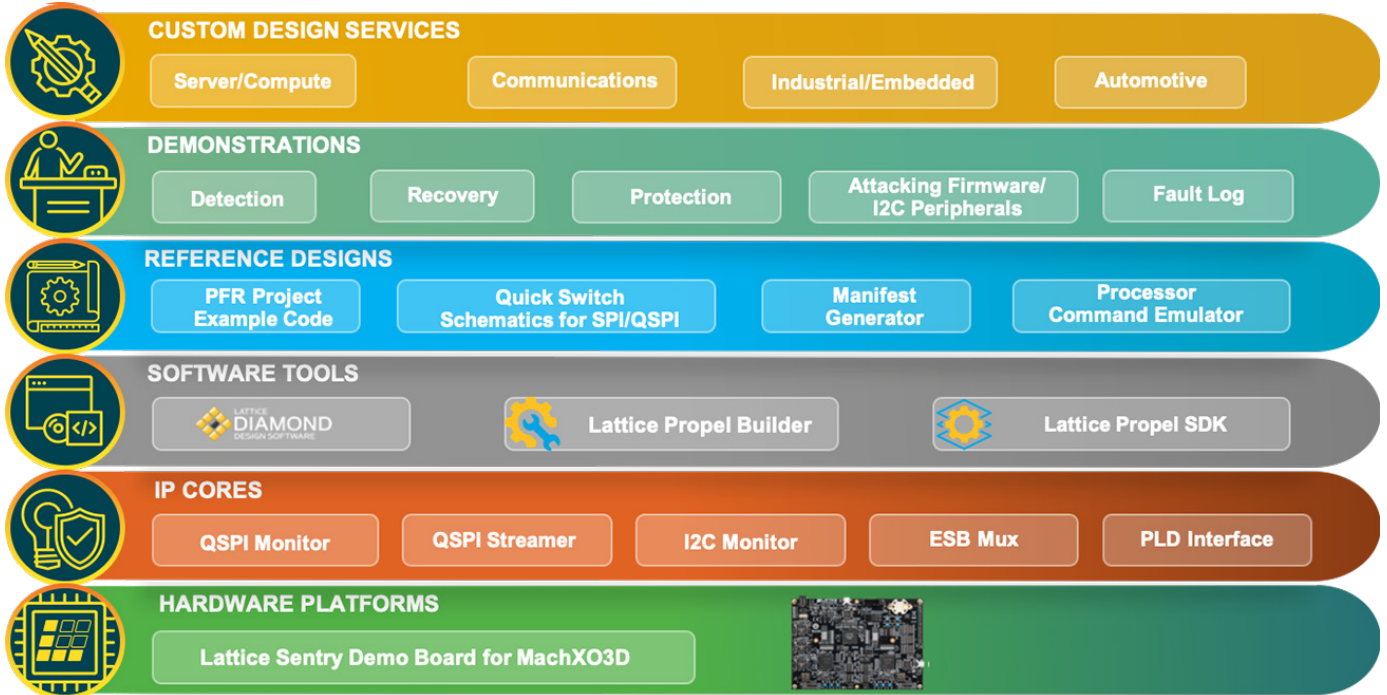

Complete solution toolkit includes everything needed to create a custom Platform Firmware Resiliency (PFR) Implementation

Solution allows secure protection of firmware before, during, and after system boot.

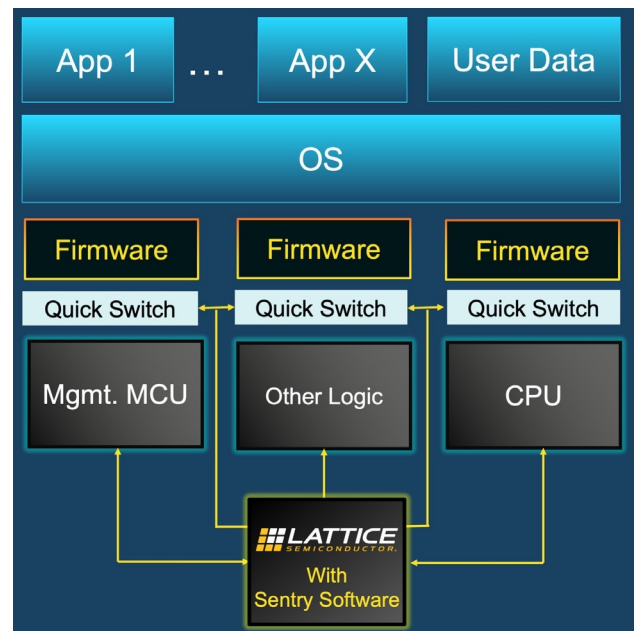

Solution Stack – Lattice Sentry

Proven Lattice Sentry IP Cores

- QSPI Streamer
- QSPI Monitor
- I2C Monitor
- PLD Interface
- Embedded Security Block Mux
- RISC-V CPU

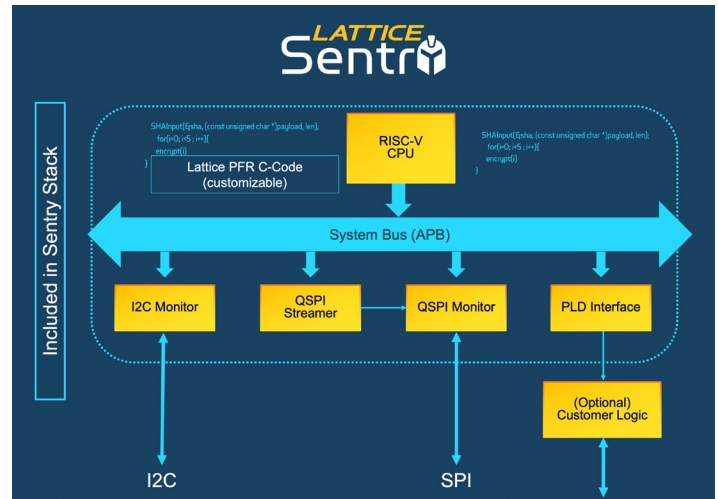

Easy To Use Lattice Design Tools



Plug & Play Lattice Sentry Reference Designs

- PFR Project Example Code
- QuickSwitch Schematics for SPI/QSPI
- Manifest Generator
- Processor Command Emulator

Instructive Lattice Sentry Demonstrations

- Protection
- Detection
- Recovery
- Attacking Firmware/I2C Peripherals
- Fault Log
- Implemented on Lattice Sentry Demo Board for MachXO3D

Lattice Sentry Custom Design Services

Have customized PFR needs for your design or market? The Lattice Sentry solution is fully customizable, and Lattice has a global Application Services staff who can perform custom IP development if needed. These customizations can enable a resilient PFR solution across a wide range of end applications, including Communications, Industrial, Client Computing, Automotive and Datacenter. Please contact your local Lattice sales agent to request more information.

For more information go to LATTICESEMI.COM/SENTRY

Lattice Automate™ Solution Stack

Accelerating Factory Automation

Lattice Automate™ helps designers accelerate high performance, low power, secure solutions for next generation factory automation solutions. The stack includes modular hardware development boards and software-programmable reference designs and demos that simplify and accelerate implementation of applications like robotics, scalable multi-channel motor control with predictive maintenance, and real-time industrial networking.

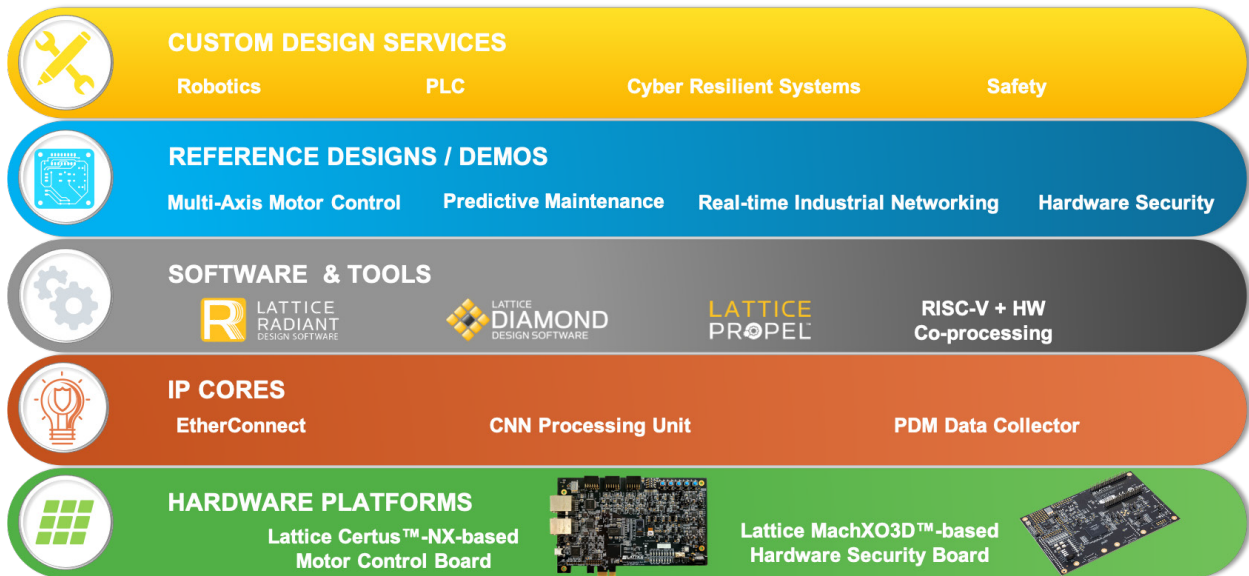

Hardware Platform

The Lattice Automate solution stack runs on the Certus-NX Versa development board which supports the main processing subsystem, connections to the Host PC, and also the embedded real time Ethernet links. The Motor Control nodes also utilize the Versa board.

IP Cores

- EtherConnect – Enables compact, low power, modular real-time sense and control over embedded Ethernet connections
- CNN Processing Unit – Provides AI accelerator for Predictive Maintenance processing
- PDM Data Collector – Collects data from the Motor Control Nodes for input to the CNN Processing Unit

Design Tools

Lattice's Automate solution stack uses Lattice's standard Radiant and Diamond FPGA design tools and Lattice Propel™, enabling RISC-V based SW and HW co-processing for ease of use and fast system design.



Solution Stack – Lattice Automate

Reference Designs & Demos

Multi-Channel Motor Control with Predictive Maintenance and Embedded Real Time Networking.

- Multi-Channel BLDC Motor Control
- Embedded Real-Time Networking
- AI enabled support for Predictive Maintenance
- GUI for controlling and monitoring the design

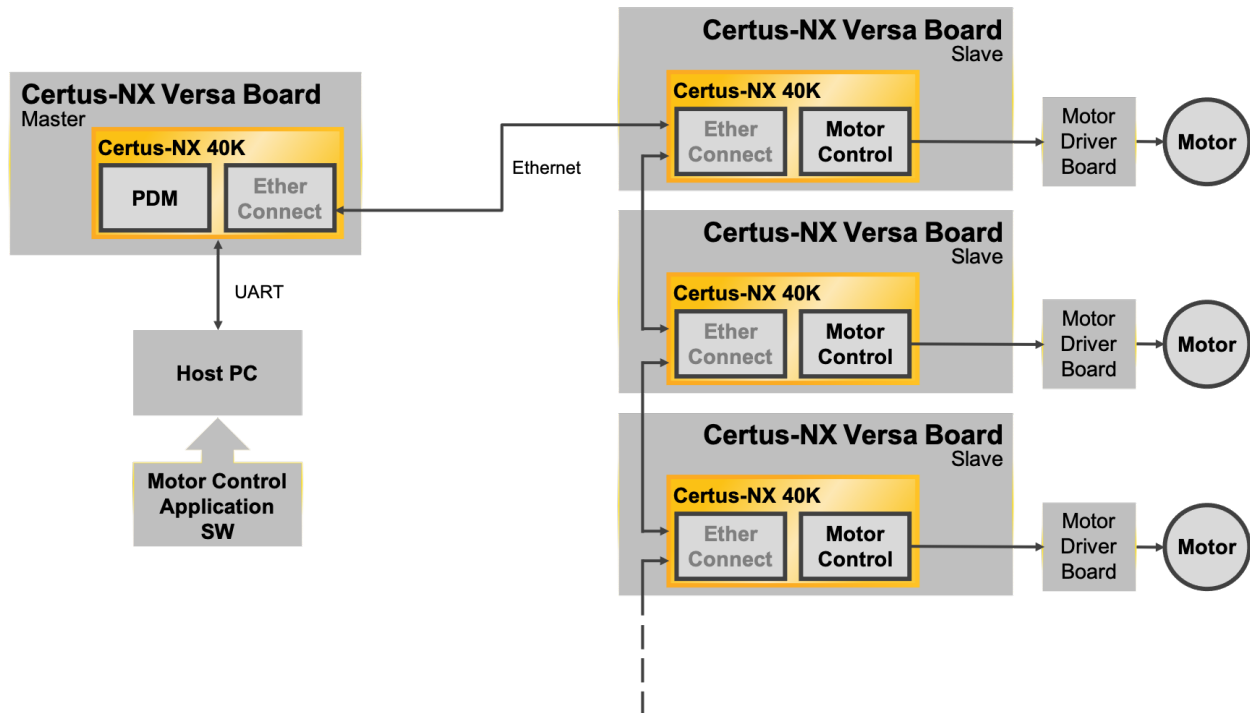

Demo Hardware

- Certus-NX Versa. Platform with 5G PCIe, SGMII, DDR3 Memory and 40k Logic Cells. Main Controller and Nodes use the Certus-NX Versa board.
- Trenz Pmod compatible motor driver board, 15A 0-30V.
- Anaheim Automation BLY17 Series Brushless DC Motor.
- HW RoT Reference Design for Cyber Resiliency using MachXO3D
 - Demonstrate and test the ability to authenticate firmware of protected devices before boot
 - Detect and block illegal SPI and Flash operations
 - Automatically replace compromised firmware in the protected subsystem

Lattice Automate Custom Design Services

Need help putting together solutions for Factory Automation? The Lattice Automate stack includes an ecosystem of select, global design service partners that can deliver custom solutions for a range of end-applications, including factory, smart home, smart city, and smart cars. Please contact your local sales representative to request more information.

For more information go to LATTICESEMI.COM/AUTOMATE

FPGA Products

General Purpose FPGAs

Features			CertusPro™-NX		Certus™-NX	
Device			LFCPNX-50	LFCPNX-100	LFD2NX-17	LFD2NX-40
Logic Cells ¹ (k)			52	96	17	39
EBR SRAM	Blocks		96	208	24	84
	kbits		1728	3744	432	1512
Distributed RAM	kbits		344	639	80	240
Large RAM (LRAM)	Blocks		4	7	5	2
	kbits		2048	3584	2560	1024
Multipliers	18 x 18		96	156	24	56
PCIe Hard IP			1 (Gen3, 8 Gbps)	1 (Gen3, 8 Gbps)		1 (Gen2, 5 Gbps)
PCIe Lanes			4	4		1
SERDES maximum speed	Gbps		10	10		5
SGMII (1.25 Gbps) CDR Hard IP			2	2	2	2
SGMII (1.25 Gbps) Lanes			2	2	2	2
GPLL			3	4	2	3
ADC Blocks			2	2	2	2
450 MHz High Frequency Oscillator			1	1	1	1
128 KHz Low Power Oscillator			1	1	1	1
DDR Memory Support (Up to 1066 Mbps)			LPDDR4, LPDDR2, DDR3/3L		LPDDR2, DDR3/3L	
Boot Flash			External		External	
Dual Boot			✓		✓	
Multiple Boot			✓		✓	
Bitstream Encryption (AES-256)			✓		✓	
Bitstream Authentication (ECDSA)			✓		✓	
Full-chip Configuration Time ² (ms)			TBD	29	8	14
I/O Configuration Time ² (ms)			TBD	4	3	3
Core Vcc			1.0 V		1.0 V	
Temp.	C		✓		✓	
	I		✓		✓	
	A (AEC-Q100)				✓	
0.5 mm Spacing (Package type, #Balls, Size)			Total I/O (Wide Range, High Performance, ADC³) / SERDES Lanes		Total I/O (Wide Range, High Performance, ADC³) / 5G PCIe Lane	
csfBGA	121	6 x 6 mm	77 (23, 48, 6) / 0	81 (23, 58, 0) / 1	78 (24, 48, 6) / 0 ⁴	82 (24, 58, 0) / 1 ⁴
0.8 mm Spacing (Package type, #Balls, Size)			Total I/O (Wide Range, High Performance, ADC³) / SERDES Lanes		Total I/O (Wide Range, High Performance, ADC³) / 5G PCIe Lane	
caBGA	196	12 x 12 mm				157 (93, 58, 6) / 0
	256	14 x 14 mm				192 (112, 74, 6) / 1 ⁴
CBG256	256	14 x 14 mm	170 (TBD) / 4	165 (75, 84, 6) / 4		
BBG484	484	19 x 19 mm	230 (TBD) / 4	305 (167, 132, 6) / 8		
1.0 mm Spacing (Package type, #Balls, Size)			Total I/O (Wide Range, High Performance, ADC³) / SERDES Lanes		Total I/O (Wide Range, High Performance, ADC³) / 5G PCIe Lane	
BFG484	484	23 x 23 mm	230 (TBD) / 4	305 (167, 132, 6) / 4		
LFG672	672	27 x 27 mm		305 (167, 132, 6) / 8		

1) Logic Cells = LUTs x 1.2 effectiveness
2) QSPI mode at 150 MHz nominal frequency
3) Dedicated inputs for ADC
4) Available in Automotive Grade

FPGA Products

General Purpose FPGAs

Features			ECP5™-5G			ECP5 Automotive			ECP5™						LatticeECP3™					
Device			LFE5UM5G-25	LFE5UM5G-45	LFE5UM5G-85	LAE5UM-25	LAE5UM-45	LAE5U-12	LFE5UM-25	LFE5UM-45	LFE5UM-85	LFE5U-12	LFE5U-25	LFE5U-45	LFE5U-85	LFE3-17EA	LFE3-35EA	LFE3-70EA	LFE3-95EA	LFE3-150EA
LUTs			24 k	44 k	84 k	24 k	44 k	12 k	24 k	44 k	84 k	12 k	24 k	44 k	84 k	17 k	33 k	67 k	92 k	149 k
EBR SRAM	# of Blocks		56	108	208	56	108	32	56	108	208	32	56	108	208	38	72	240	240	372
	kbits		1008	1944	3744	1008	1944	576	1008	1944	3744	576	1008	1944	3744	700	1,327	4,420	4,420	6,850
Distrib RAM	kbits		194	351	669	194	351	97	194	351	669	97	194	351	669	36	68	145	188	303
sysDSP™ Blocks	Multipliers		28	72	156	28	72	28	28	72	156	28	28	72	156	24	64	128	128	320
SERDES	Max. Chan.		1/2	2/4		1/2	2/4	0	1/2	2/4	0	0	0	0	4	12	16			
	Max. Rate		5 Gbps			3.2 Gbps			3.2 Gbps						3.2 Gbps					
PLL + DLL			2+2	4+4		2+2	4+4	2+2	2+2	4+4	2+2	2+2	4+4		2+2	4+2	10+2			
DDR Support			DDR3 800, LPDDR3 800, DDR3L 800			DDR3 800, LPDDR3 800, DDR3L 800			DDR3 800, LPDDR3 800, DDR3L 800						DDR3 800, DDR2 533, DDR 400					
Boot Flash			External			External			External						External					
Dual Boot			✓			✓			✓						✓					
Multiple Boot			✓			✓			✓											
Bit-stream Encryption			✓			✓			✓						✓					
Core Vcc			1.2 V			1.1 V			1.1 V						1.2 V					
Temp.	C		✓						✓						✓					
	I		✓						✓						✓					
	AEC-Q100					✓									✓					
0.5 mm Spacing			I/O Count / SERDES			I/O Count / SERDES			I/O Count / SERDES											
csfBGA	285	10 x 10 mm	118/2	118/2	118/2				118/2	118/2	118/2	118/0	118/0	118/0	118/0					
csBGA	328	10 x 10 mm													116/2					
0.8 mm Spacing			I/O Count / SERDES			I/O Count / SERDES			I/O Count / SERDES											
caBGA	256	14 x 14 mm										197/0	197/0	197/0						
	381	17 x 17 mm	197/2	203/4	205/4	197/2	203/4	197/0	197/2	203/4	205/4	197/0	197/0	203/0	205/0					
	554	23 x 23 mm		245/4	259/4					245/4	259/4			245/0	259/0					
	756	27 x 27 mm			365/4						365/4				365/0					
1.0 mm Spacing			I/O Count / SERDES			I/O Count / SERDES			I/O Count / SERDES											
ftBGA	256	17 x 17 mm													133/4	133/4				
fpBGA	484	23 x 23 mm													222/4	295/4	295/4	295/4		
	672	27 x 27 mm														310/4	380/8	380/8	380/8	
	1156	35 x 35 mm															490/12	490/12	586/16	

Video Connectivity

CrossLink Series – Embedded Vision FPGAs

Features			CrossLink™							CrossLinkPlus™		
Device			LIF-MD6000-6UWVG36	LIF-MD6000-6UMG64	LIF-MD6000-6MG81	LIF-MD6000-6JMG80	LIF-MD6000-6KMG80	LIA-MD6000-6MG81	LIA-MD6000-6JMG80	LIA-MD6000-6KMG80	LIF-MDF6000-6UMG64	LIF-MDF6000-6KMG80
LCs (k)			7							7	7	
EBR SRAM	Blocks		20							20	20	
	kbits		180							180	180	
Distributed RAM	kbits		47							47	47	
MIPI D-PHY	Port	1	2							2	2	
	Lane	4	8							8	8	
	Max Rate		1.5 Gbps							1.5 Gbps	1.5 Gbps	
GPLL			1							1	1	
Edge Clock		2	4							4	4	
Boot Flash			External							Internal	Internal	
Dual Boot			External							External	External	
Internal Configuration Memory			NVCM							Flash	Flash	
Temp	C		✓								✓	✓
	I		✓								✓	✓
	AEC-Q100						✓	✓	✓			
0.4 mm Pitch			I/O (Low Speed/High Speed)							I/O (L/H)		
WLCSP	36	2.5 x 2.5 mm	17/10									
ucfBGA	64	3.5 x 3.5 mm		29/22							29/22	
0.5 mm Pitch			I/O (Low Speed/High Speed)							I/O (L/H)		
csfBGA	81	4.5 x 4.5 mm			37/30			37/30				
0.65 mm Pitch			I/O (Low Speed/High Speed)							I/O (L/H)		
ctfBGA	80	6.5 x 6.5 mm				37/30			37/30			
ckfBGA	80	7 x 7 mm					37/30			37/30	37/30	

Video Connectivity

CrossLink Series – Embedded Vision FPGAs

Features		CrossLink™-NX									
Device		LIFCL-17-7UWG72	LIFCL-17-7SG72	LIFCL-17-7MG121	LIFCL-17-7BG256	LIFCL-40-7SG72	LIFCL-40-7MG121	LIFCL-40-7MG289	LIFCL-40-7BG256	LIFCL-40-7BG400	
LCs (k)		17				39					
EBR SRAM	Blocks	24				84					
	kbits	432				1512					
Distributed RAM	kbits	80				240					
Large Memory (LDRAM)	Blocks	5				2					
	kbits	2560				1024					
Multipliers	18 x 18	24				56					
MIPI D-PHY	Port	1	1	2	2	1	2	2	2	2	
	Lane	4	4	8	8	4	8	8	8	8	
	Max Rate	2.5 Gbps									
PCIe (5 Gbps)	Port								1	1	1
	Lane								1	1	1
SGMII	Channel	2									
	Max Rate	1.25 Gbps									
GPLL		2				3					
Edge Clock		8	8	12	12	8	12	12	12	12	
DDR Support (Up to 1066 Mbps)		LPDDR3				LPDDR3, DDR3/3L					
Boot Flash		External									
Dual Boot		External									
Multiple Boot		✓									
Internal Configuration Memory		None									
Bit-stream Encryption		✓									
Temp	C	✓									
	I	✓									
	A (AEC-Q100)			✓	✓		✓		✓		
0.4 mm Pitch		I/O (Low Speed/High Speed)									
WLCSP	72	3.7 x 4.1 mm	16/20								
0.5 mm Pitch		I/O (Low Speed/High Speed)									
QFN	72	10 x 10 mm		18/22			18/22				
csBGA	121	6 x 6 mm			24/48			24/48			
csBGA	289	9.5 x 9.5 mm						106/74			
0.8 mm Pitch		I/O (Low Speed/High Speed)									
caBGA	256	14 x 14 mm			24/48				78/74		
	400	17 x 17 mm								118/74	

Ultra Low Power

iCE40 Series – World's Smallest FPGAs

Features		iCE40 UltraPlus		iCE40 UltraLite		iCE40 Ultra			iCE40 LP				iCE40 HX		
Device	UP3K	UP5K	UL640	UL1K	LP1K	LP2K	LP4K	LP384	LP640	LP1K	LP4K	LP8K	HX1K	HX4K	HX8K
Logic	2800	5280	640	1248	1100	2048	3520	384	640	1280	3520	7680	1280	3520	7680
NVCM	Yes	Yes	Yes	Yes	Yes	Yes	Yes	Yes	Yes	Yes	Yes	Yes	Yes	Yes	Yes
Static Power (µA)	75	75	35	35	71	71	71	21	100	100	250	250	296	1140	1140
EBR	80 kb	120 kb	56 kb	56 kb	64 kb	80 kb	80 kb	0	64 kb	64 kb	80 kb	128 kb	64 kb	80 kb	128 kb
SPRAM	0.5 Mb	1 Mb													
PLL	1	1	1	1	1	1	1			1	2	2	1	2	2
I ² C core	2	2	2	2	2	2	2								
SPI Core	2	2			2	2	2								
Strobe (low)															
Strobe (high)															
Low Power Oscillator	1	1	1	1	1	1	1								
High Frequency Oscillator	1	1	1	1	1	1	1								
24 mA Drive	3	3	3	3	3	3	3		3	3 ³					
100 mA + 400 mA Drive			1	1											
500 mA Drive					1	1	1								
Mult 16 x 16, Accum 32 bit	4	8			2	4	4								
PWM Generator	Yes	Yes	Yes	Yes	Yes	Yes	No								
0.35 mm Spacing		Total I/Os (Dedicated I/Os)^{4,5}													
WLCSP	16	1.40 x 1.40 mm								11(1) ¹	11(1) ¹				
	16	1.40 x 1.48 mm			10	10									
	25	1.71 x 1.71 mm													
	36	2.08 x 2.08 mm					27(1)	27(1)	27(1)						
0.4 mm Spacing		Total I/Os (Dedicated I/Os)^{4,5}													
WLCSP	30	2.15 x 2.55 mm	21	21											
	36	2.5 x 2.5 mm			26	26			27(2)		27(2) ¹				
ucBGA	49	3 x 3 mm							39(2)		37(2) ¹				
	81	4 x 4 mm									65(2)	65(2) ²	65(2) ²		
	121	5 x 5 mm									97(2)	95(2)	95(2)		
	225	7 x 7 mm										180(2)	180(2)		180(2)
0.5 mm Spacing		Total I/Os (Dedicated I/Os)^{4,5}													
QFN	32	5 x 5 mm							23(2)						
	48	7 x 7 mm		39			39	39	39						
	84	7 x 7 mm									69(2) ¹				
csBGA	81	5 x 5 mm									64(2) ¹				
	121	6 x 6 mm									94(2)				
	132	8 x 8 mm											97(2)	97(2)	97(2)
VQFP	100	14 x 14 mm											74(2) ¹		
TQFP	144	20 x 20 mm											98(2)	109(2)	
0.8 mm Spacing		Total I/Os (Dedicated I/Os)^{4,5}													
caBGA	121	9 x 9 mm													95(2)
	256	14 x 14 mm													208(2)

1) No PLL available on the 16 WLCSP, 36 ucBGA, 81 csBGA, 84 QFN and 100 VQFP packages.

2) Only one PLL available on the 81 ucBGA package.

3) 24 mA constant current sink available on the 16 WLCSP package only.

4) Total I/Os include dedicated I/Os.

5) Dedicated I/Os are defined to be pins that are dedicated and cannot be used by user logic after configuration.

Control and Security

Mach-NX & MachXO3/3D - Secure, Control Bridging and I/O Expansion FPGAs

Features			Mach™-NX	MachXO3D™			MachXO3L™					MachXO3LF™					
Device			LFMNX-50	LCMXO3D-4300	LCMXO3D-9400	LCMXO3L-640	LCMXO3L-1300	LCMXO3L-2100	LCMXO3L-4300	LCMXO3L-6900	LCMXO3L-9400	LCMXO3LF-640	LCMXO3LF-1300	LCMXO3LF-2100	LCMXO3LF-4300	LCMXO3LF-6900	LCMXO3LF-9400
LUTs			11280 ⁸	4300	9400	640	1300	2100	4300	6900	9400	640	1300	2100	4300	6900	9400
EBR SRAM	# of Blocks		48	10	48	7	7	8	10	26	48	7	7	8	10	26	48
	kbits		432	92	432	64	64	74	92	240	432	64	64	74	92	240	432
Distrib. RAM	kbits		73	34	73	5	10	16	34	54	73	5	10	16	34	54	73
UFM	kbits		1064/2669 ⁴	367/1122 ⁴	1088/2693 ⁴							64	64	80	96	256	448
Configuration Memory			Dual Flash	Dual Flash	Dual Flash	Internal NVM					Flash						
Dual Boot			√ ⁶	√ ⁶		√ ⁵					√ ⁵						
Embedded Function Blocks			I ² C (2), SPI (1), Timer (1)			I ² C (2), SPI (1), Timer (1)					I ² C (2), SPI (1), Timer (1)						
Crypto Key Strength (bits)			384	256	256												
Core Vcc	1 V		√														
	1.2 V			√ ⁷				√						√			
	2.5 - 3.3 V			√	√			√						√			
Temp.	Auto			√	√									√			
	Com		√	√	√			√						√			
	Ind		√	√	√			√						√			
0.4 mm Spacing			Total I/Os														
WLCSP	36 ¹	2.5 x 2.5 mm					28						28				
	49 ¹	3.2 x 3.2 mm						38						38			
	81 ¹	3.8 x 3.8 mm							63						63		
0.5 mm Spacing			Total I/Os														
QFN	72	10 x 10 mm		58	58												
csfBGA	121 ¹	6 x 6 mm					100						100				
	256 ¹	9 x 9 mm						206						206			
	324	10 x 10 mm						268	268	281				268 ⁷	268 ⁷	281	
0.65 mm Spacing			Total I/Os														
WLCSP	69 ¹	5.2 x 6.2 mm			58												
0.8 mm Spacing			Total I/Os														
caBGA	256	14 x 14 mm	200	206 ⁷	206 ⁷			206 ²			206 ³			206 ⁷	206 ²	206 ³	
	324	15 x 15 mm						279 ²						279 ⁷	279 ²		
	400	17 x 17 mm			335				335 ²		335 ³				335 ²	335 ³	
	484	19 x 19 mm	379		383 ⁷						384 ³						384 ³

1) Package is only available for E=1.2 V devices.

2) Package is only available for C=2.5 V/3.3 V devices.

3) Package is available for both E=1.2 V and C=2.5 V/3.3 V devices.

4) When Dual Boot is disabled, image space can be repurposed as extra UFM.

5) Dual Boot supported with external boot Flash.

6) Dual Boot is supported by on chip dual configuration flash memory.

7) Available in automotive grade

8) Shown in LCs

Control and Security

MachXO2 & LatticeXP2 Series – Bridging and I/O Expansion FPGAs

Features			MachXO2™							LatticeXP2™						
Device			LCMXO2-256	LCMXO2-640	LCMXO2-640U	LCMXO2-1200	LCMXO2-1200U	LCMXO2-2000	LCMXO2-2000U	LCMXO2-4000	LCMXO2-7000	LFXP2-5E	LFXP2-8E	LFXP2-17E	LFXP2-30E	LFXP2-40E
LUTs			256	640	640	1280	1280	2112	2112	4320	6864	5 k	8 k	17 k	29 k	40 k
EBR SRAM # of Blocks			0	2	7	7	8	8	10	10	26	9	12	15	21	48
kbits			0	18	64	64	74	74	92	92	240	166	221	276	387	885
Distrib. RAM kbits			2	5	5	10	10	16	16	34	54	10	18	35	56	83
UFM kbits			0	24	64	64	80	80	96	96	256					
sysDSP™ Blocks																
18x18 Blocks												3	4	5	7	8
Multipliers												12	16	20	28	32
PLL + DLL						1+2			2+2			2+0			4+0	
DDR Support						DDR 266, DDR2 266, LPDDR266					DDR/2 400					
Configuration Memory			Internal Flash									Internal Flash				
Dual Boot ⁴							✓									✓
Bit-stream Encryption																✓
Embedded Function Blocks			I ² C (2), SPI (1), Timer (1)													
Core Vcc			ZE & HE													
1.2 V																✓
1.8 - 3.3 V																
2.5 - 3.3 V							HC								HC	
Temp. C							✓								✓	
Temp. I							✓								✓	
AEC-Q100												✓				
0.4 mm Spacing																
WLCSP	25	2.5 x 2.5 mm				18			18							
	36	2.5 x 2.5 mm				28										
	49 ²	3.2 x 3.2 mm						38								
	81	3.8 x 3.8 mm								63						
ucBGA	64	4 x 4 mm	44													
0.5 mm Spacing																
QFN	32	5 x 5 mm	21			21										
	48	7 x 7 mm	40	40												
	84	7 x 7 mm							68							
csBGA	100	8 x 8 mm														
	132	8 x 8 mm	55	79		104		104		104						
	184 ¹	8 x 8 mm								150 ¹						
	132	8 x 8 mm									86					
TQFP	100	14 x 14 mm	55	78		79		79								
	144	20 x 20 mm			107	107		111		114	114	100				
0.8 mm Spacing																
caBGA	256	14 x 14 mm						206		206	206					
	332	17 x 17 mm								274	278					
1.0 mm Spacing																
ftBGA	256	17 x 17 mm				206	206		206	206	172		201			
	324	19 x 19 mm														
fpBGA	484	23 x 23 mm						278	278	334			358	363		
	672	27 x 27 mm												472	540	

1) Contact your Lattice sales representative for the support of the 184-ball csBGA package, available with the HE option only.

2) Package is only available for E=1.2 V devices.

3) Package is only available for C=2.5 V/3.3 V devices.

4) Dual Boot supported with external boot Flash.

Power and Thermal Management Products

Manage power, thermal & control planes in real time

Features		Power & Thermal Management		
		L-ASC10	LPTM21	LPTM21L
Voltage Monitoring Inputs		10	10	10
Current Monitoring Inputs		2	2	2
Temperature Monitoring Inputs		2	2	2
Number of Trimming Channels		4	4	4
MOSFET Drives		4	4	4
On-Chip Non-Volatile Fault Log		✓	✓	✓
Number of LUTs			1280	1280
Distributed RAM (kbits)			10	10
EBR SRAM (kbits)			64	64
Number of EBR Blocks (9 kbits)			7	7
Number of PLLs			1	1
Number of Macrocells				
Communication I/F		I ² C	I ² C/JTAG	I ² C/JTAG
Programming Interface		I ² C	I ² C/JTAG	I ² C/JTAG
Operating Voltage		3.3 V	2.8 V to 12 V	2.8 V to 12 V
In-system Update Support		✓	✓	✓
Temp.	I	✓	✓	✓
	AEC-Q100			
Package Options		Digital I/Os		
48-pin QFN (7 x 7 mm)		9 ⁵		
237-Ball ftBGA (1 mm) (17 x 17 mm)			95 + 10 ⁴	
100-pin TQFP (14 x 14 mm)				
100-Ball caBGA (10 x 10 mm)				32 + 10 ⁶
48-pin TQFP (7 x 7 mm)				
32-pin QFN (5 x 5 mm)				
24-pin QFN (4 x 4 mm)				

- 1) POWR1220AT8 provides 6 (5 V Tolerant) digital inputs and 16 (5 V Tolerant) open-drain digital outputs
- 2) POWR1014 & PWOR1014A provide 4 (5 V Tolerant) digital inputs and 12 (5 V Tolerant) open-drain digital outputs
- 3) POWR607 & PWOR605 provide 2 (5 V Tolerant) digital inputs and 5 (5 V Tolerant) open drain I/O
- 4) LPTM21 provides 95 (3.3 V Tolerant) logic I/Os and 10 (5 V Tolerant) open-drain I/O
- 5) 5 V Tolerant open drain I/O
- 6) LPTM21L provides 32 (3.3 V Tolerant) logic I/Os and 10 (5 V Tolerant) open-drain I/O

IP Cores and Reference Designs

IP Cores

Lattice IP Cores are pre-tested, reusable functions, that allow designers to focus on their unique system architectures. These IP cores provide industry-standard functions such as PCI Express, DDR, Ethernet, CPRI, and embedded microprocessors. In addition, a number of independent IP providers have teamed with Lattice to offer additional high quality, reusable IP cores. Partners are selected for their industry leadership, high development standards, and commitment to customer support. For a complete listing of IP cores from Lattice and its 3rd party partners, please go to latticesemi.com/IP. Note that a Diamond Subscription License and the IP license are required to use the IP for production.

	IP Core	CertusPro-NX	Certus-NX	CrossLink-NX	Mach-NX	CrossLink	CrossLinkPlus	iCE40 UltraPlus
Communications	10 Gb Ethernet MAC	✓						
	SGMII and Gb Ethernet PCS	✓	✓	✓				
	Triple Speed 10/100/1G Ethernet MAC	✓	✓	✓				
Connectivity	10 Gb Ethernet PCS	✓						
	GPIO	✓	✓	✓				
	PCI Express x1 Endpoint	✓	✓	✓				
	PCI Express x2 Endpoint	✓						
	PCI Express x4 Endpoint	✓						
	PCI Express Root Complex Lite x1	✓	✓	✓				
	PCI Express Root Complex Lite x4	✓						
Digital Signal Processing	CORDIC	✓	✓	✓				
	Divider	✓	✓	✓				
	FFT Compiler	✓	✓	✓				
	FIR Filter Generator	✓	✓	✓				
Processor, Controller & Peripheral	DDR3 SDRAM Contoller	✓	✓	✓				
	DDR3 SDRAM PHY	✓	✓	✓				
	I ² C Master	✓	✓	✓				
	I ² C Slave	✓	✓	✓				
	I ³ C Master	✓	✓	✓				✓
	I ³ C Slave	✓	✓	✓				✓
	LPDDR2 SDRAM Controller Lite	✓	✓	✓				
	LPDDR4 SDRAM Controller	✓						
	Multi-Port Arbiter for DDR3 Memory Controller	✓	✓	✓				
	Scatter Gather DMA	✓	✓	✓				
	SPI Master	✓	✓	✓				
	SPI Slave	✓	✓	✓				
	UART 16550	✓	✓	✓				✓
	Watchdog Timer	✓	✓	✓				
Neural Network Accelerators	CNN Plus Accelerator		✓	✓				
	Compact CNN Accelerator							✓
Lattice Propel	AHB Lite Interconnect Module		✓	✓	✓			
	AHB Lite to APB Bridge Module		✓	✓	✓			
	APB Interconnect Module		✓	✓	✓			
	I ² C Master		✓	✓				
	RISC-V MC CPU IP		✓	✓	✓			
	RISC-V SM CPU IP		✓	✓	✓			
	SGMII and Gb Ethernet PCS		✓	✓				
	System Memory Module		✓	✓	✓			
	UART IP Core		✓	✓	✓			
Video & Imaging	2D Scaler	✓	✓	✓				
	4:1 MIPI CSI-2 Bridge					✓	✓	
	Byte to Pixel Converter	✓	✓	✓		✓	✓	
	Color Space Converter	✓	✓	✓				
	CMOS to MIPI D-PHY Interface Bridge					✓	✓	
	1:2 and 1:1 MIPI CSI-2 to CSI-2 Camera Interface Bridge					✓	✓	
	MIPI CSI-2 Bridge					✓	✓	
	CSI-2/DSI D-PHY Receiver	✓	✓	✓		✓	✓	
	CSI-2/DSI D-PHY Transmitter	✓	✓	✓		✓	✓	
	Deinterlacer	✓	✓	✓				
	DSI to DSI					✓	✓	
	FPD-LINK Receiver		✓	✓		✓	✓	
	FPD-LINK Transmitter		✓	✓		✓	✓	
	Gamma Corrector	✓	✓	✓				
	MIPI D-PHY to CMOS					✓	✓	
	MIPI DSI Bandwidth Reducer					✓	✓	
	Display Interface Bridge					✓	✓	
	MIPI DSI to OpenLDI/FPD-Link/LVDS					✓	✓	
	Pixel to Byte Converter	✓	✓	✓				
	SLVS-EC Receiver	✓						
	SubLVDS Image Sensor Receiver	✓	✓	✓		✓	✓	
SubLVDS to MIPI CSI-2 Image Sensor Interface Bridge					✓	✓		
Video Frame Buffer	✓	✓	✓					

1) Contact Lattice for version support information.

IP Cores and Reference Designs

	IP Core	ECP5/ECP5-5G	ECP3	ECP2M	ECP2	MachXO2	MachXO3D	XP2
Communications	10 Gb Ethernet MAC	✓	✓	✓	✓			
	2.5 Gb Ethernet MAC		✓					
	2.5 Gb Ethernet PCS		✓					
	CPRI	✓	✓	✓				
	CPRI 5G	✓	✓					
	SPI4	✓	✓	✓				
	SGMII and Gb Ethernet PCS	✓	✓	✓	✓			✓
	Triple Speed 10/100/1G Ethernet MAC	✓	✓	✓	✓			✓
XAUI	✓	✓	✓					
Connectivity	JESD204A		✓					
	JESD204B	✓	✓					
	JESD207	✓	✓					
	PCI Express x1 Endpoint	✓	✓	✓				
	PCI Express x2 Endpoint	✓						
	PCI Express x4 Endpoint	✓	✓	✓				
	PCI Express Root Complex Lite x1	✓	✓	✓				
	PCI Express Root Complex Lite x4	✓	✓	✓				
	PCI Express x1 Endpoint - Optimized for ECP5UM5G	✓						
	PCI Express x2 Endpoint - Optimized for ECP5UM5G	✓						
	PIPE		✓					
	PCI Master/Target 33		✓	✓	✓	✓		✓
	PCI Master/Target 66		✓	✓	✓	✓		✓
	PCI Target 33		✓	✓	✓	✓		✓
	PCI Target 66		✓	✓	✓	✓		✓
Serial RapidIO		✓						
Tri-Rate Serial Digital Interface (SDI) PHY		✓						
Digital Signal Processing	Block Convolutional Encoder		✓	✓				✓
	Block Viterbi Decoder		✓	✓				✓
	Cascaded Integrator-Comb (CIC) Filter		✓	✓				✓
	CORDIC	✓	✓	✓				✓
	Distributed Arithmetic (DA) FIR Filter		✓	✓				✓
	Divider		✓	✓				✓
	Dynamic Block Reed-Solomon Decoder		✓	✓	✓			✓
	FFT Compiler	✓	✓	✓				✓
	FIR Filter Generator	✓	✓	✓				✓
	Interleaver/De-interleaver		✓	✓				✓
	Machine Learning for ECP5	✓						
	Median Filter	✓						
	Numerically-Controlled Oscillator (NCO)		✓	✓				✓
	Peak Cancellation Crest Factor Reduction (CFR)	✓	✓					
Processor, Controller & Peripheral	DDR SDRAM Controller Pipelined		✓	✓	✓	✓		✓
	DDR2 SDRAM Controller Pipelined		✓	✓	✓	✓		✓
	DDR3 SDRAM Controller	✓	✓					
	DDR3 SDRAM PHY	✓	✓					
	LPDDR SDRAM Controller					✓		
	LPDDR2 SDRAM Controller Lite	✓						
	LPDDR3 SDRAM Controller	✓						
	Scatter Gather DMA	✓	✓	✓	✓			✓
Neural Network Accelerators	✓	✓						
Lattice Propel	AHB Lite Interconnect Module					✓	✓	
	AHB Lite to APB Bridge Module					✓	✓	
	APB Interconnect Module					✓	✓	
	EFB Module						✓	
	I ² C_Monitor						✓	
	QSPI_Master_Streamer						✓	
	QSPI_Monitor						✓	
	RISC-V MC CPU IP					✓	✓	
	RISC-V SM CPU IP					✓	✓	
	System Memory Module					✓	✓	
	UART IP Core					✓	✓	
Video & Imaging	2D Edge Detector		✓	✓	✓			✓
	2D FIR Filter		✓	✓	✓			✓
	2D Scaler	✓	✓	✓	✓			✓
	Color Space Converter	✓	✓	✓	✓	✓		✓
	Deinterlacer		✓	✓	✓			✓
	Display Interface Mux					✓		
	DVB-ASI		✓					
	Gamma Corrector	✓	✓	✓	✓			✓
Median Filter		✓	✓	✓			✓	
Video Frame Buffer	✓	✓	✓	✓			✓	

IP Cores and Reference Designs

Reference Designs

Lattice Reference Designs are reusable as-is codes that allow designers to quickly build their unique applications. These reference designs provide functions such as 7:1 LVDS, Barcode Emulation, Sensor Interfacing & Preprocessing, I²C, SPI, and MIPI solutions. For a complete listing of reference designs from Lattice, please go to: www.latticesemi.com/referencedesigns.

Name	Reference Design No.	ECP5/ ECP5-5G	Lattice ECP3	Mach XO3	Mach XO2	Lattice XP2	iCE40 LP/HX	iCE40 Ultra	iCE40 UltraPlus	Format	
										Verilog	VHDL
7:1 LVDS Video Interface	RD1030	✓	✓		✓	✓				✓	✓
8:1 Microphone Aggregation	UG-02035								✓		
8b/10b Encoder/Decoder	RD1012	✓	✓	✓	✓	✓				✓	✓
ADC Interface	RD1089		✓							✓	✓
Audio Interface Bridging	UG-02008								✓		
BSCAN - Multiple Boundary Scan Port Addressable Buffer (BSCAN1)	RD1001				✓	✓					
BSCAN - Multiple Boundary Scan Port Linker (BSCAN 2)	RD1002	✓			✓	✓					
Controller Area Network (CAN) Controller	RD1170						✓			✓	
FPGA Loader	AN8077				✓	✓					
GPIO Expander	RD1065		✓			✓				✓	✓
Graphics Acceleration	UG-02026								✓		
HDMI/DVI Interface	RD1097	✓	✓							✓	✓
HiSPi-to-Parallel Sensor Bridge	RD02062	✓	✓	✓	✓	✓				✓	✓
Human Face Identification Using CNN Accelerator IP	RD02062	✓								✓	
Human Presence Detection Using Compact CNN Accelerator IP	RD02059								✓		
I ² C Bus Controller for Serial EEPROM	RD1006	✓	✓	✓	✓	✓				✓	✓
I ² C Master Controller	RD1005	✓	✓	✓	✓	✓				✓	✓
I ² C Master Controller	RD1139						✓			✓	
I ² C Master with WISHBONE Controller	RD1046	✓	✓	✓	✓	✓				✓	✓
I ² C Slave Controller	RD1140						✓			✓	
I ² C Slave Peripheral Using Embedded Function Block - WISHBONE Compatible	RD1124			✓	✓					✓	✓
I ² C Slave to SPI Master Bridge	RD1094									✓	✓
I ² C Slave/Peripheral	RD1054	✓	✓			✓				✓	✓
I ² C to SPI Bridge	RD1172						✓			✓	✓
I ² S Controller	RD1101			✓	✓					✓	✓
I ² S Controller	RD1171						✓			✓	✓
iCE40 Ultra Barcode Emulation Reference Design	UG73							✓	✓	✓	
iCE40 Ultra Pedometer	UG76							✓	✓	✓	
iCE40 Ultra RGB LED Controller	UG75							✓	✓	✓	
iCE40 Ultra Self-Learning IR Remote	UG74							✓	✓	✓	
Key Phrase Detection Using Compact CNN Accelerator	RD02066								✓	✓	
Keypad Scanner	RD1180						✓				✓
LatticeMico32 - Embedded Processor - WISHBONE Compatible		✓	✓	✓	✓	✓				✓	✓
LatticeMico8 - Embedded Processor - WISHBONE Compatible		✓	✓	✓	✓	✓				✓	✓
LatticeMico8 Microcontroller User's Guide	RD1026			✓	✓	✓				✓	✓
LatticeMico8 to WISHBONE Interface Adapter	RD1043					✓				✓	✓
LED/OLED Driver	RD1103			✓	✓					✓	
LPC Bus Controller	RD1049		✓		✓	✓				✓	✓
MachXO2 Display Interface	RD1093				✓					✓	✓
MachXO2 I ² C Embedded Programming Access Firmware - WISHBONE Compatible	RD1129				✓					✓	
MachXO2 Soft I ² C Slave with Clock Stretching - WISHBONE Compatible	RD1186				✓					✓	
MDIO Peripheral - WISHBONE Compatible	RD1074		✓							✓	✓
MIPI CSI-2-to-CMOS Parallel Sensor Bridge	RD1146			✓	✓					✓	
MIPI DPHY Interface IP	RD1182	✓	✓	✓	✓					✓	
MIPI DSI RX to Parallel Bridge	RD1185			✓	✓					✓	

Continued on next page

IP Cores and Reference Designs

Name	Reference Design No.	CrossLink	ECP5/ ECP5-5G	Lattice ECP3	Mach XO3	Mach XO2	Lattice XP2	iCE40 LP/HX	iCE40 Ultra	iCE40 UltraPlus	Format	
											Verilog	VHDL
MxN Channel PWM	RD1175							✓				✓
NAND Flash Controller	RD1055					✓	✓				✓	✓
Object Counting Using CNN Accelerator IP	FPGA-RD-02058		✓								✓	
Object Counting Using CNN Plus Accelerator IP	FPGA-RD-02200	✓										
Panasonic Area Sensor-to-Parallel Bridge	RD1121					✓	✓					✓
Parallel to MIPI CSI-2 TX Bridge	RD1183				✓	✓						✓
Parallel to MIPI DSI TX Bridge	RD1184				✓	✓						✓
PCI Target 32 bit/33 MHz	RD1008			✓		✓	✓					✓
PCI/WISHBONE Bridge - WISHBONE Compatible	RD1045			✓			✓					✓
PWM Fan Controller - WISHBONE Compatible	RD1060				✓	✓	✓					✓
PWM Generator	RD1178							✓				✓
RAM-Type Interface for Embedded User Flash Memory - WISHBONE Compatible	RD1126					✓						
RC4 Based PRNG Generator	RD1179							✓				✓
Read and Write Usercode	RD1041				✓	✓						✓
RGMII to GMII Bridge	RD1022		✓	✓								✓
Sensor Data Buffer	UG-02011									✓		
SD Flash Controller - WISHBONE Compatible	RD1048						✓					✓
SD Host Controller	RD1165							✓				✓
SDR SDRAM Controller	RD1174				✓			✓				✓
SDR SDRAM Controller – Advanced	RD1010		✓	✓		✓	✓					✓
Simple Sigma-Delta ADC	RD1066					✓	✓					✓
SMPTE SDI Dual HD from/to 3G Level-B Converter	RD1132			✓								✓
SPI Master Controller	RD1141							✓				✓
SPI Peripheral	RD1075											✓
SPI Slave Controller	RD1142							✓				✓
SPI Slave Peripheral Using the Embedded Function Block - WISHBONE Compatible	RD1125				✓	✓						✓
SPI Slave Port Expander	RD1168							✓				✓
SPI to I ² C Bridge	RD1173							✓				✓
SPI to MIPI-DSI Bridge										✓		
SPI to UART Expander	RD1143							✓				✓
SPI Wishbone Compatible	RD1044				✓	✓	✓					✓
Sub-LVDS Serial to CMOS Parallel Sensor Bridge	RD1130					✓						✓
Sub-LVDS-to-Parallel Sensor Bridge	RD1122		✓	✓		✓	✓					✓
UART - WISHBONE Compatible	RD1042				✓	✓	✓					✓
UART (Universal Asynchronous Receiver/Transmitter)	RD1011						✓					✓
UART 16550 Transceiver	RD1138							✓				✓

IP Cores and Reference Designs

Hardware Management IP that are integrated in the Platform Designer tool simplify implementation of functions, such as Fault Logging, Fan Controller and PMBus Controller through a simple GUI interface.

Lattice Reference Designs are reusable as-is codes that allow designers to quickly build their unique applications. These reference designs provide functions such as I²C, SPI, BSCAN and LPC Bus Controller interface solutions. For a complete listing of reference designs from Lattice, please go to: www.latticesemi.com/referencedesigns.

Hardware Management IP

IP Core	MachXO2+ L-ASC10	PLATFORM MANAGER 2	Format			
			VHDL	Verilog	LogiBuilder	Analog Circuit
Fault Logging						
Hot Swap Controller						
Fan Controller						
PMBus Controller						
Trim & Margin						
Power & Reset Sequencing						
Voltage Scaling & VID						

Hardware Management Reference Designs

Name	Reference Design No.	MachXO2+ L-ASC10	PLATFORM MANAGER 2	Format	
				VHDL	Verilog
BSCAN - Multiple Boundary Scan Port Addressable Buffer (BSCAN1)	RD1001				
BSCAN - Multiple Boundary Scan Port Linker (BSCAN 2)	RD1002				
FPGA Loader	AN8077				
I ² C Bus Controller for Serial EEPROM	RD1006				
I ² C Master Controller	RD1005				
I ² C Slave Peripheral Using Embedded Function Block	RD1124				
I2S Controller	RD1101				
LPC Bus Controller	RD1049				
MachXO2 I ² C Embedded Programming Access Firmware	RD1129				
MachXO2 Soft I ² C Slave with Clock Stretching	RD1186				
NAND Flash Controller	RD1055				
PWM Fan Controller	RD1060				
RAM-Type Interface for Embedded User Flash Memory	RD1126				
Read and Write Usercode	RD1041				

CrossLink-NX Evaluation Board

Prototyping Board with Abundant I/O, PCIe 5G SERDES, Expansion Headers and 40k Logic Cells.

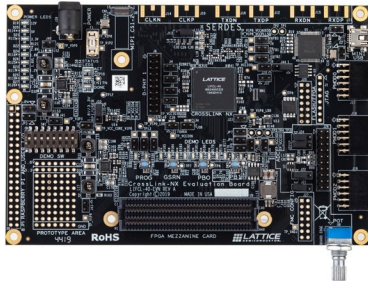

Features

- CrossLink-NX FPGA (LIFCL-40-9BG400C)
- More I/O access: 118 wide range I/O, 37 high-speed differential pair I/O, one PCIe 5G SERDES channel and most configuration pins accessible
- Expandable usability: FPGA Mezzanine Card (FMC), Raspberry Pi, Digilent Peripheral Module (Pmod™), MIPI CSI-2, D-PHY and general purpose I/O expansion headers
- USB-B connection for device programming and Inter-Integrated Circuit (I²C) utility
- On-board Boot Flash: 128 Mbit Serial Peripheral Interface (SPI) Flash, with Quad read feature
- 8 input DIP switches, 4 push buttons, 3 Status LEDs and 14 LEDs for demo purposes
- Multiple reference clock sources

Ordering Part Number

LIFCL-40-EVN

CrossLink LIF-MD6000 Master Link Board

Enables designers to streamline the development process and evaluate key connectivity features of the CrossLink FPGA.

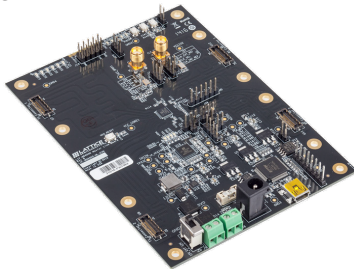

Features

- Contains the Lattice CrossLink LIF-MD6000 in 81-ball csfBGA package
- Contains four connectors for interfacing to MIPI D-PHY and high speed programmable I/O
- Includes 0.1" header board, SMA board and LEDs for interfacing and control
- Provides easy programming interface via USB with FTDI device

Ordering Part Number

LIF-MD6000-ML-EVN

CrossLink LIF-MD6000 I/O Link Boards

Allows designers to easily interface to the LIF-MD6000 Master Link Board from a variety of signal sources and sinks using standard SMA connectors.

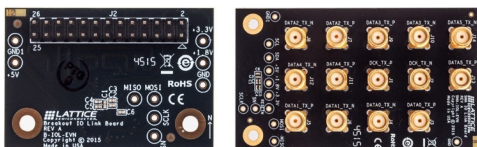

Features

- I/O Link Boards for use with Lattice LIF-MD6000 Master Link Board for SMA or low speed peripheral connections
- Contains one SMA board and one 0.1" header board

Ordering Part Number

LIFMD-IOL-EVN

iCE40 UltraPlus Single-Wire Aggregation Board

Enables designers to evaluate their single-wire interface to a prototype system to demonstrate a proof of concept in-system.

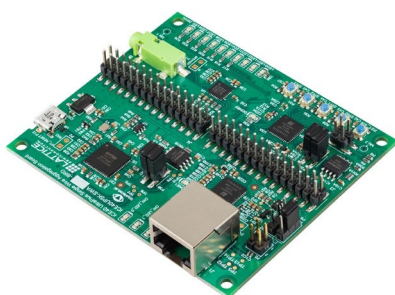

Features

- No FPGA tools knowledge necessary
- Customizable via available Reference Design
- Up to 7 channels can be aggregated
- Each channel can be either I²C, I²S or GPIO
- Board set can be configured as a stand-alone demo or in-system proof of concept

Ordering Part Number

ICE40UP5K-SWA-EVN

Himax HM01B0 UPduino Shield

A complete development kit for implementing Artificial Intelligence (AI) using the iCE40 UltraPlus with vision and sound as sensory inputs.



Features

- Lattice UltraPlus FPGA with 5.3K LUTs, 1 Mb SPRAM, 120 kb DPRAM, 8 Multipliers
- FTDI FT232H USB to SPI Device for FPGA programming
- 12 MHz Crystal Oscillator Clock Source
- 34 GPIO on 0.1" headers for connecting to the adapter board
- SPI Flash, RGB LED, 3.3 V and 1.2 V voltage regulators
- HM01B0 low power image sensor supports 30 fps at 1.1 mW
- 2 I2S microphones
- Debug LEDs

Ordering Part Number

HM01B0-UPD-EVN

iCE40 UltraPlus Mobile Development Platform

Enables designers to evaluate key connectivity features of the iCE40 UltraPlus FPGA as well as processing features utilizing multiple DSPs, integrated RAM, and FPGA fabric.

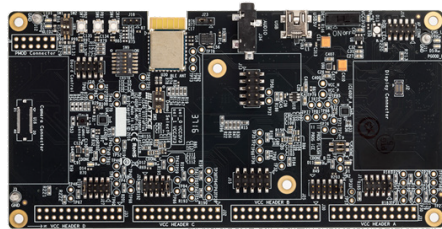

Features

- x1 MIPI DSI interface up to 108 Mbps
- 4x Microphone bridging (2x I2S mics and 2x PDM mics)
- Compass sensor (LSM303), pressure sensor (BMP180), gyro sensor (LSM330), and accelerometer (LIS2D12)
- 640 x 480 Image sensor (OVM7692)
- BLE module to transfer any captured data from iCE40 UltraPlus wirelessly
- iCE40 UltraPlus can be programmed via on-board SPI Flash or via USB port

Ordering Part Number

iCE40UP5K-MDP-EVN

iCE40 UltraPlus Breakout Board

Enables designers to evaluate key connectivity features of the iCE40 UltraPlus FPGA. The breakout board brings out all I/O and allows the FPGA to be programmed over a USB connector.

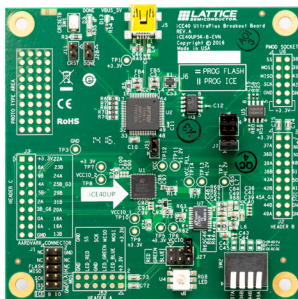

Features

- iCE40 UltraPlus (iCE40UP5K) device in a 48-pin QFN package
- High-current LED output
- iCE40UP5K application based current measurements
- Standard USB cable for device programming
- RoHS-compliant packaging and process
- Pre-loaded RGB LED Demo
- Software run GUI
- USB Connector Cable

Ordering Part Number

iCE40UP5K-B-EVN

iCE40-HX8K Breakout Board

A simple, low-cost board with an iCE40-HX8K FPGA, and generous I/O access.

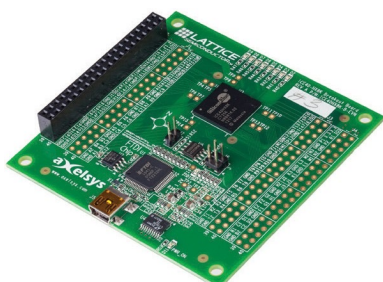

Features

- iCE40-HX8K CT256 device
- 8 user-accessible LEDs
- SPI Flash for programming configuration
- 40-pin 0.1" header for user connectivity
- 0.1" holes for user connectivity
- FTDI 2232H for USB interface
- 12 MHz oscillator
- Jumpers to select programming of the SPI Flash or iCE40-HX8K
- USB Type-A to Type-B (mini) cable for FPGA programming via PC
- Demo designs available for download

Ordering Part Number

ICE40HX8K-B-EVN

iCE40 Ultra Breakout Board

Featuring an ultra-small FPGA optimized for mobile applications. Typical mobile interfaces like RGB, IR and high current Torch LEDs are included, as well as access to every device I/O.

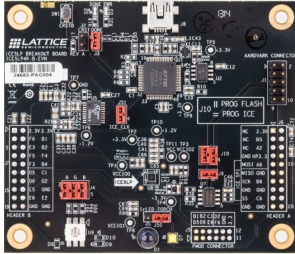

Features

- iCE5LP4K FPGA in 0.35 mm pitch, 36-ball WLCSP
- RGB LED
- High-brightness “torch” LED
- Infrared (IR) LED
- Status LEDs
- Access to all device I/O
- On-board 32 Mbit SPI Flash for reconfiguration
- Windows- & Mac-based GUI for interface to the RGB LED, includes FPGA source code
- USB Type-A to Type-B (mini) cable for FPGA power and programming via PC

Ordering Part Number

ICE5LP4K-B-EVN

iCE40 UltraLite Breakout Board

Featuring the world’s smallest FPGA optimized for mobile applications. Typical mobile interfaces like RGB, IR and high current Torch LEDs are included, as well as access to every device I/O.

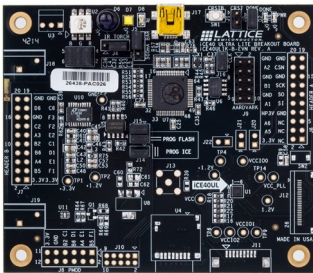

Features

- iCE40UL1K (iCE401K-CM36A) device in a 36-ball BGA package
- Layout example of a board using 0.40 mm pitch BGA package
- High current LED output
- Infrared transmit capability for remote control functions
- iCE40UL1K application-based current measurements
- Standard USB cable for device programming
- RoHS-compliant packaging and process
- Preloaded RGB LED Demo
- Software-run GUI
- USB connector cable

Ordering Part Number

iCE40UL1K-B-EVN

iCE40 Ultra Wearable Development Platform

Peripheral and sensor-rich development platform with iCE40 Ultra and MachXO2 in a wearable watch form factor.



Features

- Approximately (WxLxH) 1.50” x 1.57” x 0.87” form factor with wrist strap
- iCE40 Ultra iCE5LP4K and MachXO2 LCMXO2-2000ZE
- LG 1.54” 240 x 240 single-lane MIPI DSI display
- Bluetooth low-energy module
- Sensors: Heart-rate/SpO2, skin temperature, pressure and accelerometer/gyroscope
- 2 user LEDs, RGB LEDs, high-current white LED and high-current IR LED
- Stereo MEMs PDM microphones
- 32 Mbit Quad SPI-flash
- 27 MHz Oscillator

- Power via built-in 3.7 V, 250 mAh lithium-polymer battery or mini-USB cable
- FTDI 2232HQ USB device allows programming of FPGA and Flash
- Reference design available for download:
 - Parallel RGB to MIPI DIS bridging
 - Health monitoring*
 - Pedometer*
 - IR transmitter*
 - Flashlight*

* Reference Android APK available to interface with mobile phone over Bluetooth

Ordering Part Number

ICE5LP4K-WDEV-EVN

iCE40LP1K Evaluation Kit

Featuring our ultra-small FPGA – 1k LUTs in a 16-ball WLCSP package (0.35 mm-ball pitch), only 1.4 mm x 1.48 mm, RGB LED control, GUI available for PC or Mac interface.



Features

- iCE40LP1K in 16-WLCSP package (0.35 mm-ball pitch)
- High current tri-color LED (RGB)
- Infrared transmit LED
- Barcode emulation LED
- 27 MHz on-board oscillator
- SMA connector for external clock input
- SPI configuration Flash
- USB Type-A to Type-B (mini) cable for FPGA power and programming via PC

Ordering Part Number

ICE40LP1K-SWG16-EVN

Lattice Sentry Demo Boards for MachXO3D and Mach-NX

The Lattice Sentry Demo Board for MachXO3D or Mach-NX lets you develop, demonstrate and test a NIST 800-193-compliant PFR solution on a single board, using the MachXO3D LCMXO3D-9400HC-6BG484C, or Mach-NX LFMNX-50FBG484C as a Platform Root of Trust, and two Lattice ECP5 FPGAs which act as PFR-protected ICs in the system.

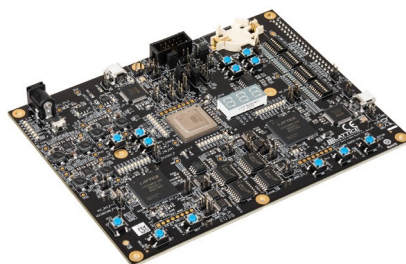
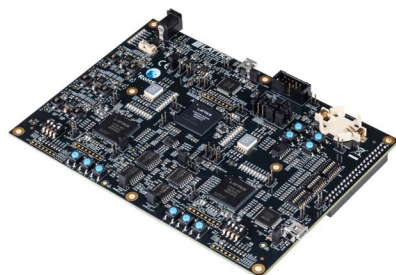

Features

- MachXO3D LCMXO3D-9400HC-6BG484C or Mach-NX FPGA - LFMNX-50FBG484C
- Power Supply (12 V)
- Lattice Sentry Solution Stack PFR demo support

- Lattice Sentry system-level behavior validation
- USB connection for device programming
- Two ECP5 FPGA devices on-board with 256 M SPI/QSPI flash devices to simulate protected external devices

Ordering Part Number

LCMXO3D-PFR-EVN

LFMNX-SENTRY-EVN

MachXO3L / MachXO3LF Starter Kit

The MachXO3L(F) Starter Kit is a basic breakout board to allow simple evaluation and development of MachXO3L(F) based designs. It includes the LCMXO3L(F)-6900C-5BG256C device.

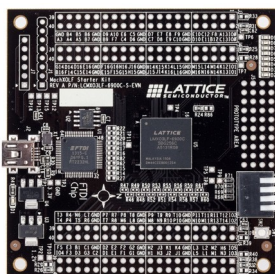

Features

- MachXO3L(F) FPGA – LCMXO3L(F)-6900C-5BG256C
- USB Type-B (mini) connector (program/power)
- Pre-programmed example design (available on latticesemi.com)
- Eight LEDs
- 4-position DIP switch

- 40-hole prototyping area
- Four 2 x 20 expansion header landings for general I/O, JTAG and external power
- 1 x 8 expansion header landing for JTAG
- 1 x 6 expansion header landing for SPI/ I²C
- SPI Flash for external boot or dual boot
- 3.3 V and 1.2 V supply rails

Ordering Part Number

LCMXO3L-6900C-S-EVN

LCMXO3LF-6900C-S-EVN

MachXO3L Breakout Board

Focusing on evaluating high-speed source synchronous interfaces with the Lattice MachXO3L-2100 and MachXO3L-6900 products in both 49-ball WLCSP and 256-ball caBGA packages respectively.

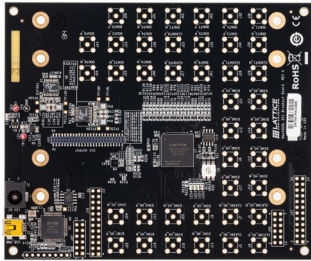

Features

- Two MachXO3L FPGAs
- XO3L-6900E in 256caBGA
- XO3L-2100E in 49WLCSP
- Two optional configurations:
 - 50-pin Harwin Archer connector for interface to DSI screen (screen not included)
 - 40 SMA connectors for LVDS I/O evaluation
- Generous prototyping/breakout access
- Switches and LEDs for user input and feedback

- Discrete resistors to support SLVS, subLVDS or DPHY Tx, and DPHY Rx, LP mode
- USB Type-A to Type-B (mini) cable for FPGA power and programming via PC
- DC jack for supplemental power input

Ordering Part Number	
MachXO3L SMA Breakout	LCMXO3L-SMA-EVN
MachXO3L DSI Breakout	LCMXO3L-DSI-EVN

MachXO3-9400 Development Board

The MachXO3-9400 Development Board is a full-featured board allowing the evaluation of MachXO3 in hardware management with L-ASC10 and I/O expansion applications utilizing the on-board connectors for Arduino and Raspberry Pi.

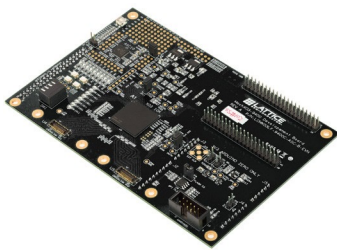

Features

- MachXO3LF-9400C-484caBGA and L-ASC10 devices with multiple prototyping and breakout areas
- Arduino and Raspberry Pi development board connectors
- LEDs and switches for demos and evaluation
- On-board FTDI device supports JTAG programming and I²C Interfacing over USB cable
- Footprint support for CrossLink I/O link connectors and ASC expansion board connectors

Ordering Part Number	
LCMXO3LF-9400C-ASC-B-EVN	

MachXO2 Boards and Kits

MachXO2 Breakout Board

Features

- MachXO2 LCMXO2-7000HE
- Access to all device I/O via four 2 x 20 expansion header landings for I/O, JTAG and external power
- 60-hole prototype area
- USB Type-B (mini) connector for power and programming (cable included)
- Eight general purpose LEDs
- 3.3 V and 1.2 V supply rails

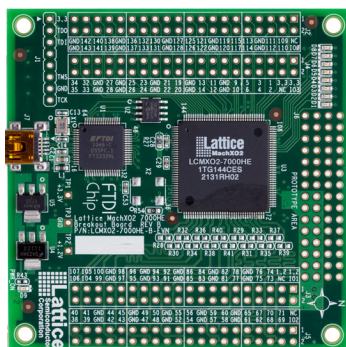

MachXO2 Pico Development Kit

Features

- MachXO2 LCMXO2-1200ZE
- 4-character, 16-segment LCD display
- 4 capacitive touch sense buttons
- 1 Mbit SPI Flash
- I²C temperature sensor
- Current and voltage sensor circuits
- Expansion header for JTAG, I²C
- Standard USB cable for device programming and I²C communication
- RS-232/USB & JTAG/USB interface
- RoHS-compliant packaging and process
- Watch battery

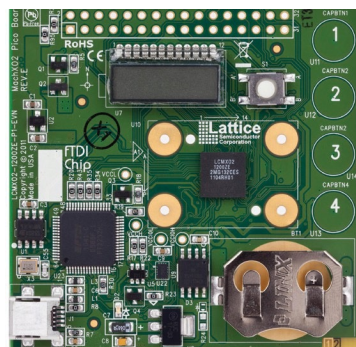

MachXO2 Control Development Kit

Features

- MachXO2 LCMXO2-4000HC
- Power Manager II ispPAC-POWR1014A
- 128 Mbit LPDDR memory, 4Mbit SPI Flash
- Current and voltage sensor circuits
- SD memory card socket
- Microphone
- Audio amplifier and Delta-Sigma ADC
- Up to two DVI sources and one DVI output.
- Up to two Display inputs (7:1 LVDS) and one Display output (7:1 LVDS)
- Audio output channel
- Expansion header for JTAG, SPI, I²C and PLD I/O.
- LEDs & switches
- Standard USB cable for device programming
- RS-232/USB & JTAG/USB interface
- RoHS-compliant packaging and process
- AC adapter (international plugs)

Ordering Part Number	
Breakout Board	LCMXO2-7000HE-B-EVN
Pico Development Kit	LCMXO2-1200ZE-P1-EVN
Control Development Kit	LCMXO2-4000HC-C-EVN

Certus-NX Versa Evaluation Board

Connectivity Platform with 5G PCIe, SGMII, DDR3 Memory and 40k Logic Cells.

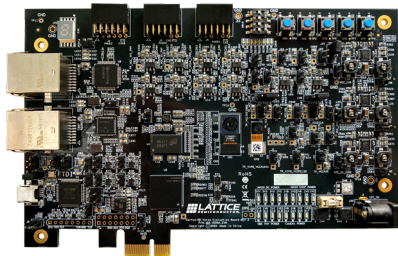

Features

- Certus-NX FPGA (LFD2NX-40-8BG256C)
- Connectivity platform with 5G PCIe and SGMII: PCI Express 2.0 endpoint edge connector (x1 lane), two Gigabit Ethernet ports (one SGMII, one RGMII), DDR3 memory (with 1066 Mbps data rate x 16 data width) and two camera sensors (one using soft D-PHY interface, other using parallel interface)
- Efficient processing and expandable usability: Features Certus-NX low-power general purpose FPGA with 40k logic cells in a 256-BGA package. Board functions expandable via three Digilent

- Peripheral Module (Pmod™) headers available on the board
- USB-B connection for device programming and Inter-Integrated Circuit (I²C) utility
- On-board Boot Flash: 128 Mbit Serial Peripheral Interface (SPI) Flash, with Quad read feature
- Four input DIP switches, five push buttons, eight status LEDs and one 7-segment LED for customer purposes
- Multiple reference clock sources

Ordering Part Number

LFD2NX-VERSA-EVN

ECP5 Evaluation Board

Prototyping Board with Abundant Logic, I/O, 5G SERDES and Expansion Headers.

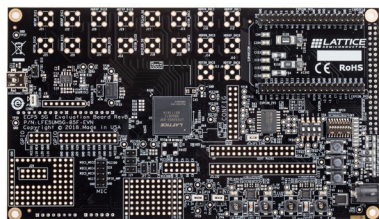

Features

- ECP5-5G FPGA (LFE5UM5G-85F-8BG381)
- More I/O access: 178 I/O (including 20 differential pair I/O), four 5G SERDES, and most configuration pins accessible
- Expandable usability: Arduino, Raspberry Pi, Digilent Peripheral Module (Pmod™), Microphone Daughter Card (MDC) and general purpose I/O expansion headers
- USB-B connection for device programming and Inter-Integrated Circuit (I²C) utility and

- future capability to support Improved Inter-Integrated Circuit (I³C)
- On-board Boot Flash: 128 Mbit Serial Peripheral Interface (SPI) Flash, with Quad read feature
- 8 input DIP switches, 3 push buttons and 8 LEDs for demo purposes
- Multiple reference clock sources

Ordering Part Number

LFE5UM5G-85F-EVN

ECP5 and ECP5-5G Versa Development Kits

For evaluation and development with the ECP5 and ECP5-5G FPGAs, including PCI Express, Gigabit Ethernet, DDR3 and generic SERDES performance.

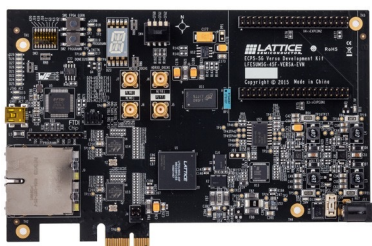

Features

- Half-length PCI Express form factor: allows demonstration of PCI Express x1 interconnection
- Electrical testing of one full-duplex SERDES channel via SMA connections
- USB Type-B connection for UART and device programming
- Two RJ45 interfaces to 10/100/1000 Ethernet to RGMII
- On-board boot Flash: 128 Mbit Serial SPI Flash
- DDR3-1866 memory components (64 Mbit/x16)

- Expansion mezzanine interconnection for prototyping
- 14-segment alphanumeric display
- Switches, LEDs and displays for demo purposes
- Diamond® programming support
- On-board reference clock sources

Ordering Part Number

LFE5UM-45F-VERSA-EVN

LFE5UM5G-45F-VERSA-EVN

LatticeECP3 Versa Development Kit

Industry's lowest cost platform for designing PCI Express and Gigabit Ethernet based systems. The kit includes free demos and reference designs.

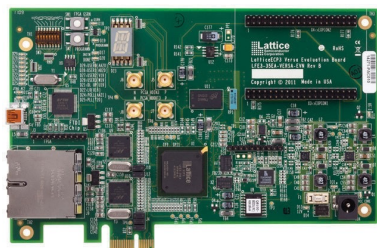

Features

- The LatticeECP3 Versa Evaluation Board:
 - PCI Express 1.1 x1 Edge connector interface
 - Two Gigabit Ethernet ports (RJ45)
 - 4 SMA connectors for SERDES access
 - USB Type-B (mini) for FPGA programming
 - LatticeECP3 FPGA: LFE3-35EA-FF484
 - 64 Mbit Serial Flash memory
 - 1GB DDR3 Memory
 - 14 segment alphanumeric display
 - Switches and LEDs for demos
- SERDES Eye Quality Demo

- 4 PCI Express Demos
- Gigabit Ethernet MAC Demo using Mico32
- DDR3 Memory Controller Demo
- Available on Windows and Linux platforms
- USB Type-A to Type-B (mini) cable for FPGA programming via PC
- 12 V AC power adapter and international plug adapters

Ordering Part Number

LFE3-35EA-VERSA-EVN

LatticeXP2 Brevia2 Development Kit

Easy-to-use, low-cost platform for evaluating and designing with LatticeXP2 FPGAs.

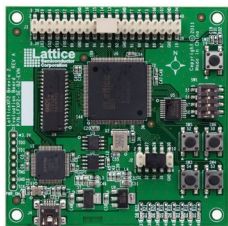

Features

- LatticeXP2 FPGA: LFXP2-5E-6TN144C
- 2 Mbit SPI Flash memory
- 1 Mbit SRAM
- Programmed via included mini-USB Cable
- 2 x 20 and 2 x 5 expansion headers
- Push buttons for general purpose I/O and reset
- 4-bit DIP Switch for user-defined inputs
- 8 Status LEDs for user-defined outputs

Ordering Part Number
LFXP2-5E-B2-EVN

Embedded Vision Development Kit

Embedded Vision Development Kit with dual-camera to HDMI bridging, features CrossLink, ECP5 and Sil1136 devices. The kit's modular platform simplifies development and offers flexibility for design expansion.

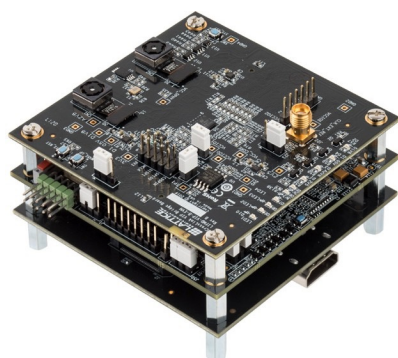

Features

- All-inclusive demo system with on-board video sources
- CrossLink LIF-MD6000 input board with two Sony IMX 214 high-speed MIPI D-PHY interface camera sensors
- ECP5 processor board with pre-loaded high definition Image Signal Processing IP (HD ISP)
- Sil1136, non-HDCP, output board connects any HDMI
- Includes 0.1" header prototyping
- Easy programming interface via USB with FTDI device
- Modular Video Interface Platform (VIP) allows mixing and matching of input and output boards
- Develop custom video interface solutions for embedded vision and machine learning using Lattice Diamond Software

Ordering Part Number
LF-EVDK1-EVN

CrossLink-NX VIP Sensor Input Board

CrossLink-NX VIP Sensor Input Board, expands multi-sensor connectivity and processing to the Embedded Vision Development Kit.

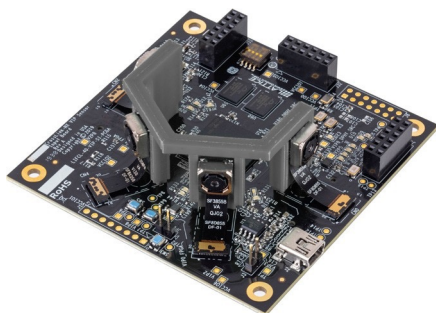

Features

- Four on-board Sony IMX 256 image sensors
- Three PMOD connectors for flexible sensor connectivity
- Contains the Lattice CrossLink-NX
- Optimized for easy sensor aggregation
- Supports 4K/2K @60 fps or 1080p @60 fps
- Complements Embedded Vision Development Kit by providing for fast prototyping

Ordering Part Number
LIFCL-VIP-SI-EVN

DisplayPort VIP Input Board

DisplayPort VIP Input Board, expands video connectivity to the Embedded Vision Development Kit with the inclusion of DisplayPort RX and embedded DisplayPort RX.

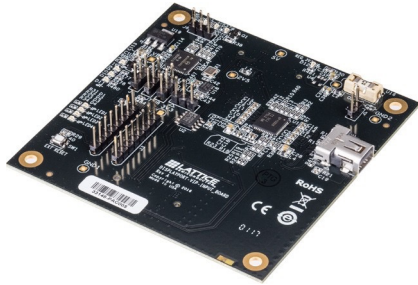

Features

- Supports DisplayPort 1.4 up to 2.7 Gbps
- Integrated Texas Instruments SN75DP130 DisplayPort 1:1 Redriver
- Mini DisplayPort (mDP) connector
- Two 60-pin rugged high-speed headers
- Modular Video Interface Platform (VIP) with eDP RX feature support
- Develop custom video interface solutions for embedded vision and machine learning using Lattice Diamond Software

Ordering Part Number

DP-VIP-I-EVN

DisplayPort VIP Output Board

DisplayPort VIP Output Board, expands video connectivity to the Embedded Vision Development Kit with the inclusion of DisplayPort TX and embedded DisplayPort TX.



Features

- Supports DisplayPort 1.4 up to 2.7 Gbps
- Integrated Texas Instruments SN75DP130 DisplayPort 1:1 Redriver
- Mini DisplayPort (mDP) connector
- Two 60-pin rugged high-speed headers
- Modular Video Interface Platform (VIP) with eDP TX feature support
- Develop custom video interface solutions for embedded vision and machine learning using Lattice Diamond Software

Ordering Part Number

DP-VIP-O-EVN

USB3-GbE VIP IO Board

USB3-GbE VIP IO Board provides USB 3.1 and Gigabit Ethernet connectivity by converting the output of the ECP5 VIP Processor Board into a standard USB 3.1 and Gigabit Ethernet interface.



Features

- Two Unified 60-pin high speed connectors
- On board Cypress FX3 USB 3.1 controller
- Compliant with USB 3.1 specification revision 1.0
- Supports standard USB 3.0 interface
- On board industrial grade TI DP83867IR Gigabit Ethernet PHY
- Supports 10/100/1000 Ethernet

Ordering Part Number

USB3-VIP-EVN

Machine Learning Adapter Card

The Machine Learning Adapter Card adds external memory and microphone input to the ECP5 VIP Processor Board.

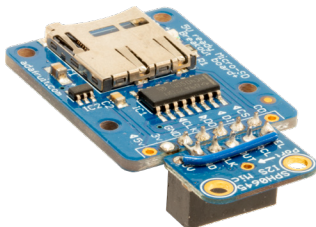

Features

- Includes 8 GB MicroSD card
- Includes Microphone Input
- Easy connection to ECP5 VIP Processor Board, included in Embedded Vision Development Kit

Ordering Part Number

ML-ADP-EVN

HDMI VIP Input Bridge Board

The HDMI VIP Input Bridge Board complements the Embedded Vision Development Kit by providing two selectable HDMI input signals for fast

prototyping. The board converts two unencrypted HDMI input video signals into a parallel RGB video format.

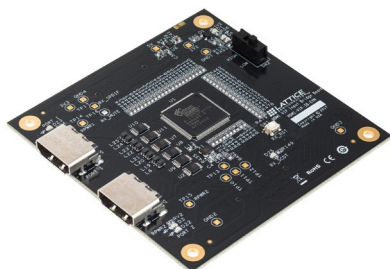

Features

- 2 switchable HDMI input signal
- Contains the Lattice Si1127A
- Transfer of non-HDCP input data
- Support of 1080p @ 60 Hz HDMI-compliant digital audio and video
- Can be used as stand-alone board or combined with the Embedded Vision Development Kit

Ordering Part Number

HDMI-VIP-IB-EVN

Lattice USB 3.0 Video Bridge Development Kit

This is a production-ready, high-definition video capture and conversion system, based on the LatticeECP3™ FPGA family.

Features

- Production-ready USB 3.0 audio/video bridging reference design
- 1080p video streaming over USB 3.0 @60 fps
- HDMI 1.4a audio and video capture
- SD-, HD-, 3G-SDI audio and video capture
- Supports video capture from external MIPI CSI-2, SubLVDS or Parallel sensors
- Reference design provides fast USB 3.0 UVC and UAC class data packing

- Plug and play operations as a video capture device on multiple standard platforms (Windows, MacOS, Linux)
- Complete reference design schematics and documentation available

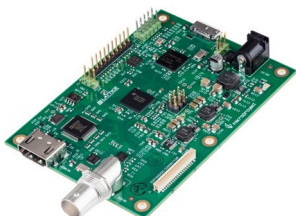

Ordering Part Number

LFE3-17EA-USB3-EVN

Platform Manager 2 Development Kit

The Platform Manager 2 Development Kit is a versatile, ready-to-use hardware platform for evaluating and designing with Platform Manager 2 and L-ASC10 devices. This kit includes a board, programming cable, and assorted example designs and documentation available for download. You can implement and debug your hardware management functions (power, thermal and control plane management) and test them out with this kit.

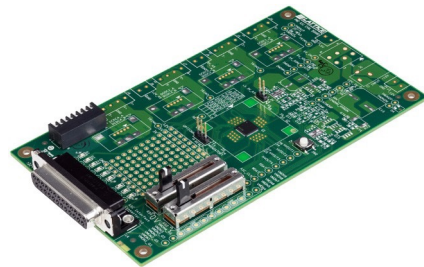
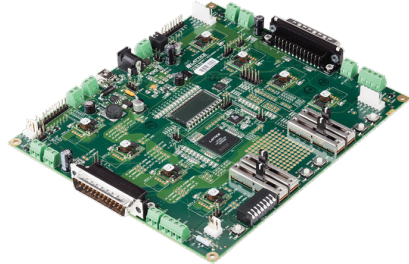

Features

- LPTM21 (Platform Manager 2 device) & L-ASC10 (Hardware Management expander)
- Temperature monitoring/measurement, with temperature control using fan (included)
- Fault logging under various types of hardware management faults
- 4 potentiometers & 2 POLs for sequencing, VID/Voltage scaling, margining, fault creation
- Background programming support with Dual boot from golden image stored on the SPI Flash
- Hardware management expansion through external L-ASC10 boards
- 3-digit LCD for additional code debug support

L-ASC10 Breakout Board

The L-ASC10 (ASC) Breakout Board is a versatile hardware platform for evaluation and design with L-ASC10 devices. The board is designed to work alongside the Platform Manager 2 Development Kit.

Features

- L-ASC10 (Hardware Management Expander)
- 2 potentiometers for sequencing & fault creation
- 9 LEDs for sequencing
- Temperature monitor & measurement with 2 on-board temperature sensors
- Connector for use with Platform Manager 2 Development Kit

Ordering Part Number	
Platform Manager 2 Development Kit	LPTM-BPM-EVN
L-ASC10 Breakout Board	LPTM-ASC-B-EVN

Programming Hardware

Programming Cables

Lattice Programming Cables are used to communicate between a PC and a Lattice device on a target board or system. The most common application is to program a Lattice device. Programming Cables can also be used to help debug your hardware designs via Lattice software tools.

- **USB Programming Cable (HW-USBN-2B – pictured).** The latest-generation Programming Cable adds I²C programming and various other features.
- **Parallel Cable (HW-DLN-3C).** This connects to a PC parallel port and is best for basic JTAG programming.



Ordering Part Number	
ispDOWNLOAD Parallel Cable	HW-DLN-3C
USB Programming Cable	HW-USBN-2B

Smart Sockets

Lattice Smart Sockets are an all-in-one solution for prototype programming of the latest Lattice products.

These complete solutions include all the functionality of a Desktop Programmer + Socket Adapter combination in a single board. All that's needed is a simple connection to your PC via USB (cable included).

More information about Lattice Smart Sockets is on the Lattice website at www.latticesmi.com/sockets.



Desktop Programmers

Lattice offers two desktop programmers for prototype programming of Lattice products.

A Socket Adapter is required for the specific device/package you wish to program. These are available separately, and are designed specifically for one Desktop Programmer or the other.

The Lattice Model 300 Desktop Programmer (pictured) supports most Lattice FPGA and CPLD products.

The iCEprog Desktop Programmer supports all Lattice iCE products.



Ordering Part Number	
Model 300 Desktop Programmer	PDS4102-PM300N
iCEprog Desktop Programmer	ICEPROGM1050-01

Socket Adapters

Lattice Socket Adapters are used in conjunction with a Lattice Desktop programmer to facilitate low-volume, manual programming of Lattice devices.

Socket adapters are generally designed to support a device family/package combination.

iCE Socket Adapters work only with the iCEprog Desktop Programmer. All other Lattice Socket Adapters work only with the Model300 Desktop Programmer.

More information and a complete list of Lattice Socket Adapter products is available at www.latticesmi.com/sockets.



FPGA and CPLD Design Software

Best in Class Design Tools

	Lattice Radiant (Free)	Lattice Diamond™ (Subscription)	Lattice Diamond™ (Free)	ispLEVER™ Classic (Subscription)	iCEcube2™ (Free)	PAC-Designer	Lattice Propel
Device Families	Certus-NX	✓					
	CrossLink		✓	✓			
	CrossLinkPlus		✓	✓			
	CrossLink-NX	✓					
	ECP5UM5G		✓				
	ECP5U		✓	✓			
	ECP5UM		✓				
	LatticeECP3		✓				
	LatticeECP2M/S		✓				
	LatticeECP2S		✓				
	MachXO/XO2/XO3		✓	✓			
	MachXO3D		✓	✓			✓
	Mach-NX		✓	✓			✓
	LatticeXP2		✓	✓			
	LatticeECP2		✓	✓			
	iCE40					✓	
	iCE40 UltraPlus	✓			✓		
	ispMACH 4000B/C/N/ZE						
	Platform Manager 2		✓	✓			
	L-ASC10		✓	✓			
Power Manager II						✓	
Software Features	Design Exploration	✓	✓	✓		✓	
	VHDL & Verilog Support	✓	✓	✓	✓	✓	
	Schematic Support	✓	✓	✓	✓		
	ABEL				✓		✓
	Synopsys® Synplify Pro™ for Lattice-Synthesis	✓	✓	✓	✓		
	Lattice Synthesis Engine (LSE)	FPGA only	MachXO/XO2/ XO3/XO3D Lattice ECP2/ ECP3/ECP5/ ECP5-5G/ ECP2M/XP2	MachXO/XO2/ MachXO3/XO3D LatticeECP2/ ECP5U/XP2	ispMACH 4000 only	✓	
	Embedded Security Block		FPGA only				
	Security / Encrypted Bit-Stream	CrossLink-NX	✓				
	IP and Module Configuration	✓	✓	✓	Module Only	Module Only	
	Power Estimation & Calculation	✓	✓	✓		✓	
	Propel Builder						✓
	Propel SDK						✓
	Timing Analysis	✓	✓	✓	✓	✓	
	Floorplanning	✓	✓	✓	✓	✓	
	On-Chip Debug	✓	✓	✓	ispXPGA Only		
TCL Scripting Dictionaries	✓	✓	✓				
Aldec® Active-HDL Lattice Edition Simulation	Windows Only	Windows Only	Windows Only	Windows Only	Windows Only		
Operating Systems	Windows 7/10 (64 bit)	✓	✓	✓	✓		✓
	Linux (RHEL v6 and v7)(64-bit)	✓	✓	✓		✓	
Licensing & Updates	License Terms	One Year – Renewable	One Year – Renewable	One Year – Renewable	One Year – Renewable	One Year – Renewable	One Year – Renewable
	Node-Locked License	✓	✓	✓	✓	✓	✓
	Floating License		✓	✓	✓		✓

Neural Network Compiler for sensAI Stack

Target	Ubuntu Linux	Microsoft Windows	CMD Line	License
CNN Accelerator IP (ECP5)	16.04	7, 10	✓	✓
CNN Plus Accelerator IP (CrossLink-NX)	16.04	7, 10	✓	✓
Compact CNN Accelerator IP (iCE40)	16.04	7, 10	✓	✓

FPGA and CPLD Design Software

Lattice Propel – Build FPGA-based Processor System in Minutes

		Lattice Radiant (Free)	Lattice Diamond™ (Subscription)	Lattice Diamond™ (Free)	ispLEVER™ Classic (Subscription)	iCEcube2™ (Free)	PAC-Designer
Device Families	CrossLink		✓	✓			
Software Features	Design Exploration	✓	✓	✓		✓	
	VHDL & Verilog Support	✓	✓	✓	✓	✓	
	Schematic Support	✓	✓	✓	✓		
	ABEL				✓		✓
	Synopsys® Synplify Pro™ for Lattice-Synthesis	✓	✓	✓	✓		
	Lattice Synthesis Engine (LSE)	FPGA only	MachXO/XO2/XO3/XO3D Lattice ECP2/ECP3/ ECP5/ECP5-5G/ ECP2M/XP2	MachXO/XO2/ MachXO3/XO3D LatticeECP2/ ECP5U/XP2	ispMACH 4000 only	✓	
	Embedded Security Block		FPGA only				
	Security / Encrypted Bit-Stream	CrossLink-NX	✓				
	IP and Module Configuration	✓	✓	✓	Module Only	Module Only	
	Power Estimation & Calculation	✓	✓	✓		✓	
	Timing Analysis	✓	✓	✓	✓	✓	
	Floorplanning	✓	✓	✓	✓	✓	
	On-Chip Debug	✓	✓	✓	ispXPGA Only		
TCL Scripting Dictionaries	✓	✓	✓				
Aldec® Active-HDL Lattice Edition Simulation	Windows Only	Windows Only	Windows Only	Windows Only	Windows Only		
Operating Systems	Windows 7/10 (64-bit)	✓	✓	✓	Windows 7/XP	✓	
	linux (RHEL v6 and v7)(64-bit)	✓	✓	✓		✓	
Licensing & Updates	License Terms	One Year – Renewable	One Year – Renewable	One Year – Renewable	One Year – Renewable	One Year – Renewable	
	Node-Locked License	✓	✓	✓	✓	✓	
	Floating License		✓	✓			



Software Licensing

Web: latticesemi.com/licensing

Technical Support

latticesemi.com/support

Copyright © 2021 Lattice Semiconductor Corporation, Lattice Semiconductor (& design), Certus-NX, CertusPro-NX, CrossLink, CrossLinkPlus, CrossLink-NX, iCE40, iCE40 Ultra, iCE40 UltraLite, iCE 40 UltraPlus, Mach-NX, MachXO, MachXO2, MachXO3, MachXO3D, MachXO3L, MachXO3H, ispMACH, LatticeXP2, ECP5, ECP5-G, LatticeECP3, LatticeECP2/M, Lattice Diamond, Lattice mVision, Lattice Nexus, Lattice Radiant, Lattice sensAI, Lattice Sentry, Lattice SupplyGuard, Lattice Automate, ispLever, iCEcube, iCEcube2, and specific product designations are either registered trademarks or trademarks of Lattice Semiconductor Corporation or its subsidiaries in the United States and/or other countries. MIPI is a licensed trademark of MIPI, Inc. in the U.S. and other jurisdictions.



December 2021 • Order #: 10211 Rev. 33